

CLEVERTOUCH[®]

by Boxlight[®]

86" CM Pro

User Manual

**CTL-
86DS94KV2**

English

| | |
|---|------------------------------|
| TABLE OF CONTENTS | ERROR! BOOKMARK NOT DEFINED. |
| IMPORTANT SAFETY INFORMATION | 3 |
| BATTERY SAFETY GUIDELINES | 6 |
| MARKINGS ON THE PRODUCT | 7 |
| GENERAL VIEW | 8 |
| CONTROL BUTTONS ON THE DISPLAY | 9 |
| CONNECTING THE EXTERNAL IR RECEIVER | 10 |
| TURNING THE DISPLAY ON/OFF | 10 |
| REMOTE CONTROL | 12 |
| INITIAL SETUP | 13 |
| HOMESCREEN | 13 |
| DISPLAY SETTINGS MENU CONTENT | 14 |
| NETWORK & INTERNET | 15 |
| SIGNAGE SETTINGS | 15 |
| CONTROLS | 15 |
| USB | 17 |
| OPS SETTINGS | 17 |
| SCHEDULER SETTINGS | 17 |
| LINK OPTIONS | 18 |
| VOLUME SETTINGS | 18 |
| DEVICE PREFERENCES | 19 |
| INSTALLING 3RD PARTY APPLICATIONS | 20 |
| CONNECTIVITY | 20 |
| NETWORK STANDBY MODE | 21 |
| AIRSERVER WIRELESS MIRRORING | 22 |
| APPS | 22 |
| INTERNET BROWSER | 22 |
| MEDIA PLAYER | 23 |
| CEC AND CEC RS PASSTHROUGH | 24 |
| CHANGING THE START AND SETTINGS URL'S | 24 |
| HTML5 CMS LAUNCHER | 24 |
| REAL TIME CLOCK (RTC) | 25 |
| HDMI OUT | 25 |
| CONTROLLING WITH AN EXTERNAL PC | 25 |
| RS232/LAN COMMAND TABLE | 27 |
| RS232 HEX COMMANDS | 46 |
| MAXIMUM PIXEL RATES | 50 |
| INPUT MATRIX | 50 |
| SUPPORTED MEDIA FORMATS FROM USB | 50 |
| SYSTEM FEATURES | 54 |
| ACCESSORIES INCLUDED | 54 |
| INFORMATION FOR USERS ON DISPOSAL OF OLD EQUIPMENT AND BATTERIES | 55 |
| LICENCE NOTIFICATION | 55 |
| VESA WALL MOUNT MEASUREMENTS | 56 |
| INSTALLATION ON AN INDENTED WALL | 57 |
| SAFETY WARNINGS | 58 |



Important Safety Information

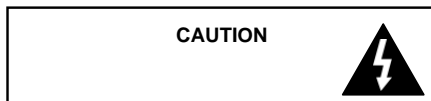

CAUTION: TO REDUCE THE RISK OF ELECTRIC SHOCK DO NOT REMOVE COVER (OR BACK). NO USER-SERVICEABLE PARTS INSIDE. REFER SERVICING TO QUALIFIED SERVICE PERSONNEL.

OPS USAGE WARNING: Do not plug the OPS unit while the Display is turned on. Turn on the OPS unit using the remote control or the buttons on the Display, do not turn it on using the buttons on the device itself.

Please read these instructions fully and carefully before use and keep for future reference

WARNING: This device is not intended for use by persons (including children) without physical, sensory or mental capabilities, or lack of experience and/or knowledge unless they have been given supervision or instruction concerning use of the device by a person responsible for their safety.

- This product is for indoor use only.
- Use this product at an altitude of less than 5000 metres above the sea level and in dry locations and in regions with moderate or tropical climates.
- Please keep this manual for further use.

- Unplug your product before starting to clean. Do not clean the product when it is on. Do not use liquid or aerosol cleaners. Use a damp cloth for cleaning. If that does not help, please use LCD display cleansers. Do not apply the cleaner directly on the product.
- To prevent breakdown, do not use non-advised accessories.
- Please do not place your product near wash basins, sinks, water pans, pools, etc.
- Do not expose the product to dripping or splashing of liquids and do not place objects filled with liquids, such as vases, cups, etc. on or over the product (e.g. on shelves above the Display).
- Please leave at least 5 cm of free space between the product and walls or other furnitures for ventilation purposes.
- That product can only be started by the defined power source on its rating plate. For further information, please contact with your dealer.
- As a safety precaution, a three-wired grounding plug is given with the product. As a safety precaution, please do not make any change on the grounding plug. Always use earthed socket outlet for product.
- Please provide the plug and socket to supply the needed power for appliance.
- Please place the product in a position that electric cables cannot be affected by the operations on the product.
- Follow all warnings and instructions marked on the product.
- Follow the on screen instructions for operating the related features.
- To prevent the risk of fire or electric shock, please do not overuse the plugs and extension cords. Please do not open the lid of the monitor to service yourself. If the required service needs are not met by an authorized service, dangerous voltage and other risks may occur.
- If you will not use the product for a long period of time, unplug the power cord from the mains.
- Put the product on a well-ventilated place and prevent from bright light, overheat and damp.
- The product should be kept in 0 C° - 40 C°. Otherwise, the appliance may be damaged permanently.
- Plug the appliance to a grounded outlet. Always use the grounded power cord supplied with your product. Manufacturer is not responsible for any damage caused unearthed usage.
- The socket-outlet shall be installed near the equipment and shall be easily accessible.
- Do not stay in contact with the parts of the product that become hot for long periods of time. Doing so may result in low-temperature burns.
- The LCD panel used in this product is made of glass. Therefore, it can break when the product is dropped or applied with impact. Be careful not to be injured by broken glass pieces in case the LCD panel breaks.
- Usage of the monitor must not be accompanied by fatal risks or dangers that, could lead directly to death, personal injury, severe physical damage or other loss, including nuclear reaction control in nuclear facility, medical life support system, and missile launch control in a weapon system.
- Do not expose the product to direct sunlight or do not place open flames such as lit candles on the top of or near the product.
- Do not place any heat sources such as electric heaters, radiators, etc. near the product.
- In order to prevent a potential electrical shock, in extreme weather (storms, lightning) disconnect the product from the mains.
- Do not touch the controls other than those described in the operating instructions. Improper adjustment of controls not described in the instructions can cause

damage, which often requires extensive adjustment work by a qualified technician.

- Do not shake the product. Ensure that it stays in a balanced stance on its position.
- Do not throw or drop any object on your product.
- Do not interfere on your products screen or any other surface with a sharp object.
- Do not keep your product in a humid environment.
- Do not keep your product in an extremely cold environment.
- Do not keep your product in an extremely hot environment.
- Do not place the product on the floor and inclined surfaces.
- To avoid danger of suffocation, keep plastic bags out of the reach of the babies, children and domestic animals.

Vent holes of the product

The vent holes are designed to provide the product to work constantly and prevent it from overheating. Do not block these openings in anyway. For the same reason, please do not place your product on beds, sofas, carpets and similar surfaces.

Never insert an object into the product through vents or openings. High voltage flows in the product, and inserting any objects in the vents or openings of the product may cause electric shock, short circuit of the internal parts and/or fire. For the same reason, do not spill water or liquid on the product.

Repair

Unless a basic implementation on the product is specified by the producers' technical department on a document, do not repair your product by yourself. Otherwise, your guarantee may get suspended and you may risk your health or your product. In case of need, consult your authorized service.

- When the cable is worn off or harmed.
- If the product has been dropped or the cabinet has been damaged.
- If the performance of the product is changed or the appliance needs to be repaired.
- When a liquid was spilled on the product or when objects have fallen into the product.
- When the product has been exposed to rain or water.
- When the product does not operate properly as described in the operating instructions.

Replacement parts

In case the product needs replacement parts, make sure that the service person uses replacement parts specified by the manufacturer, or those with the same characteristics and performance as the original parts.

Use of unauthorized parts can result in fire, electric shock and/or other danger.

Safety checks

Upon completion of service or repair work, request the service technician to perform safety checks to ensure that the product is in proper operating condition.

Wall mounting

When mounting the product on a wall, be sure to install the product according to the method recommended by the manufacturer.

- Read the instructions before mounting the product on the wall.
- The wall mount kit is optional. You can obtain from your local dealer, if not supplied with the product.
- Do not install the product on a ceiling or on an inclined wall.
- Use the specified wall mounting screws and other accessories.
- Tighten the wall mounting screws firmly to prevent the product from falling. Do not over-tighten the screws.

Power Cord

- The power cord is used to disconnect the product from the mains and therefore it must remain readily operable. If the product is not disconnected electrically from the mains, the device will still draw power for all situations even if the product is in standby mode or switched off.
- Use only the power cord supplied with the monitor.
- Do not damage the power cord nor place heavy objects on it, stretch it, over bend it or step on it. Also, do not add extension cords. Damage to the cord may result in fire or electric shock.
- When unplugging the appliance, always pull directly on the plug. Do not pull from the cable when unplugging the appliance.
- Do not use the power cord with a power tap. Adding an extension cord may lead to fire as a result of overheating.
- Do not remove or insert the power plug with wet hands. Doing so could result in electric shock.
- Unplug the power cord if it is not used for a long time.
- Do not attempt to repair the power cord if it is broken or malfunctioning. When damaged it must be replaced, this should only be done by qualified personnel.

Especially for child safety

- Don't allow children to climb on or play with the monitor.
- Don't place the monitor above furniture that can easily be used as steps.

- Remember that children can become excited while watching a program, especially on a "larger than life" monitor. Care should be taken to place or install the monitor where it cannot be pushed, pulled over, or knocked down.
- Care should be taken to route all cords and cables connected to the monitor so that they cannot be pulled or grabbed by curious children.

Connections

 Be sure to turn off the main power switch and disconnect the plug from the power outlet before connecting/disconnecting cables. Also, read the manual of the equipment to be connected.

Be careful not to confuse the input terminal with the output terminal when connecting cables. Accidentally reversing cables connected to the input and output terminals may cause malfunctions and other problems.

In the case of USB fault condition, maximum current is below 5A.

Positioning

If a monitor is positioned in an unstable or inclined location, it can be potentially hazardous due to falling. Many injuries, particularly to children, can be avoided by taking simple pre-cautions such as:

- Using fixing devices like wall mount brackets recommended or supplied by the manufacturer.
- Educating children about the dangers of climbing on furniture to reach the monitor or its controls. If your existing product is being retained and relocated, the same considerations as above should be applied

Transport and Shipping

- Your device must be kept in its original package to protect from damage to its accessories during transport and shipping.
- Keep the product in normal position during transport.
- Do not drop the device during transport and protect it against impacts.
- Damages and faults that occur during transport after the delivery of the appliance to the customer are not included in the warranty cover.
- Product transportation, installation, repair and servicing must be done by qualified technical service personnel.

Intended Use

- This product is intended to be used in public places such as schools, offices, theatres, places of worship.
- Product is only suitable for connecting commercial mains socket outlets. Do not connect product industrial socket outlets.

Foreseeable misuse and incorrect use

- For apparatus intended to be used in vehicles, ships or aircraft or at altitudes exceeding 5000m above sea level, for outdoor use or in general for the application other than mentioned in user manual additional requirements may be necessary.



CAUTION



Do not leave a static image displayed for prolonged period of time. If a static image is displayed continuously for a long period of time, that image may cause image sticking on the display. This condition is not permanent, but may require a considerable amount of operational display time to dissipate, depending upon the degree of image stick. 120 minutes of continuous motion display will eliminate most image sticking effects at normal room temperature (not lower than 10 C).

As the nature of the TFT technology, you may see some amount of bright, dark, red, green and blue dots and sparklings on the screen, those do not affect the performance of the computer and are not accepted as a defect.

Warning

This is a class A. In a domestic environment this may cause radio interference in which case the user may be required to take adequate measures.

Battery Safety Guidelines

Used correctly, domestic batteries are a safe and dependable source of portable power. Problems can occur if they are misused or abused resulting in leakage or, in extreme cases, fire or explosion.

Here are some simple guidelines to safe battery use designed to eliminate any such problems.

- Take care to fit your batteries correctly, observing the plus and minus marks on the battery and appliance. Incorrect fitting can cause leakage or, in extreme cases, fire or even an explosion.
- Replace the whole set of batteries at one time, taking care not to mix old and new batteries or batteries of different types, since this can result in leakage or, in extreme cases, fire or even an explosion.
- Store unused batteries in their packaging and away from metal objects which may cause a short-circuit resulting in leakage or, in extreme cases, fire or even an explosion.

- Remove dead batteries from equipment and all batteries from equipment you know you are not going to use for a long time. Otherwise the batteries may leak and cause damage.
- Batteries must not be exposed to excessive heat such as sunshine, fire or the like.
- Never dispose of batteries in fire or with hazardous or flammable materials as this can cause them to explode. Please recycle dead batteries; do not put with the normal household waste.
- Never attempt to recharge ordinary batteries, either in a charger or by applying heat to them. They may leak, cause fire or even explode. There are special rechargeable batteries which are clearly marked as such.
- Supervise children if they are replacing batteries themselves in order to ensure these guidelines are followed.
- Do not ingest the battery, Chemical Burn Hazard.
- This product or the accessories supplied with the product may contain a coin/button cell battery. If the coin/button cell battery is swallowed, it can cause severe internal burns in just 2 hours and can lead to death.
- Remember that small button cell batteries such as used in some hearing aids, toys, games and other appliances, are easily swallowed by young children and this can be dangerous.
- Keep new and used batteries away from children.
- Make sure battery compartments are secure. If the battery compartment does not close securely, stop using the product and keep it away from children.
- Seek immediate medical attention if you believe batteries might have been swallowed or placed inside any part of the body.
- If leaked battery fluid gets on your skin or clothing, rinse immediately and thoroughly. If it gets into your eye, bathe your eye well rather than rubbing and seek medical treatment immediately. Leaked battery fluid that gets into your eye or your clothing may cause a skin irritation or damage your eye.

CAUTION

RISK OF EXPLOSION IF BATTERY IS REPLACED BY AN INCORRECT TYPE. DISPOSE OF USED BATTERIES ACCORDING TO THE INSTRUCTIONS.

Markings on the Product

The following symbols are used **on the product** as a marker for restrictions and precautions and safety instructions. Each explanation shall be considered where the product bears related marking only. Note such information for security reasons.



Class II Equipment: This appliance is designed in such a way that it does not require a safety connection to electrical earth.



Class II Equipment With Functional Earthing: This appliance is designed in such a way that it does not require a safety connection to electrical earth, the earth connection is used for functional purposes.



Protective Earth Connection: The marked terminal is intended for connection of the protective earthing conductor associated with the supply wiring.



Hazardous Live Terminal: The marked terminal(s) is/are hazardous live under normal operating conditions.



Caution, See Operating Instructions: The marked area(s) contain(s) user replaceable coin or button cell batteries.

Any issues which are caused by customer mis-adjustment of any software including the operating system are not covered by the warranty.

Depending on the model you buy, the actual appearance of the product may differ from the images used in this manual.

General View

Please note that connection ports and other features shown here may vary depending on the Display model.

Front Side

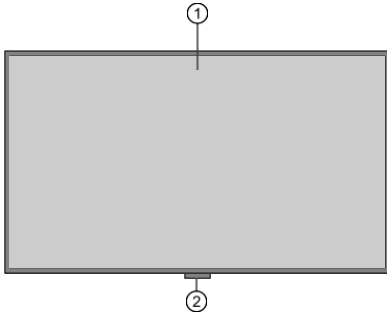

1. LCD-Panel
2. IR-Extender (Optional)

Rear Side (A)

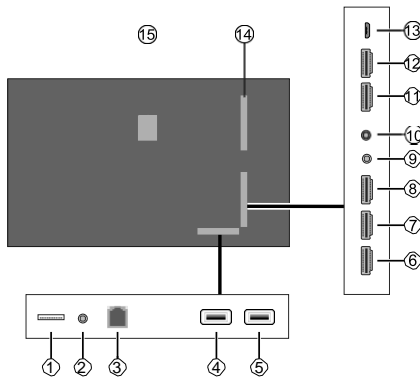

1. Micro SD
2. RS232 (3,5 mm)
3. Ethernet
4. USB (3.0) (*)
5. USB (2.0) (*)
6. HDMI2 In
7. HDMI3 In
8. HDMI4 In
9. IR Input
10. Headphone/Line Out
11. HDMI1 In
12. HDMI Out
13. Micro USB
14. Connector for PC (OPS) Module
15. Internal USB Compartment

(*) Supported file formats are listed in the **Supported Media Formats from USB** section.

Rear Side (B)

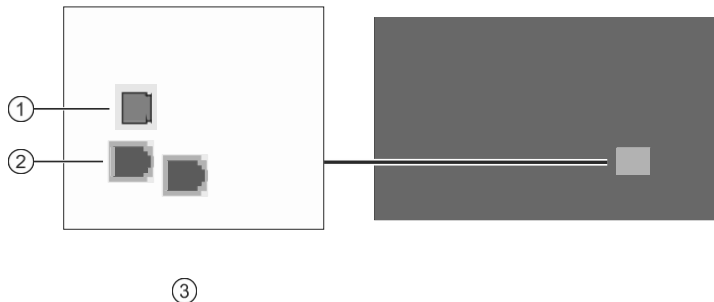

1. SPDIF Optical Out
2. RJ12 (sensor box use)
3. RJ12 (service use only)

Control Buttons on the Display



Standby State

Centre: Turn On (*)

Home Screen

Up: Move the focus up / Source menu (*)

Down: Move the focus down / Main menu (*)

Left: Move the focus left / Volume - (*)

Right: Move the focus right / Volume + (*)

Centre: Enter submenu / Select / Standby (*)

Main Menu / Submenu

Up: Move the focus up / Source menu (*)

Down: Move the focus down / Main menu (*)

Left: Move the focus left / Change the setting value / Back (*)

Right: Move the focus right / Change the setting value / Back (*)

Centre: Enter submenu / Exit (*)

Video Playback

Up: Volume + / Source menu (*)

Down: Volume - / Main menu (*)

Left: Rewind / Stop (*)

Right: Fast forward / Stop (*)

Centre: Enter submenu / Select / Standby (*)

(*) Press in and hold

Connecting the external IR Receiver

Before plugging the Display into the mains supply, connect the supplied IR receiver (depends on the model) to the IR input on the Display. Place the IR receiver in sight of your own remote control. Simply operate your remote control whilst pointed at the IR receiver and it will relay the control signal to your Display.

In case your Display has touch screen feature and if the IR receiver is going to be placed on the Display it shouldn't be placed facing the inside of the screen, otherwise the signals of the touch screen and the remote may interfere with each other. To improve the performance of your remote control place the IR receiver as shown in the drawing below.

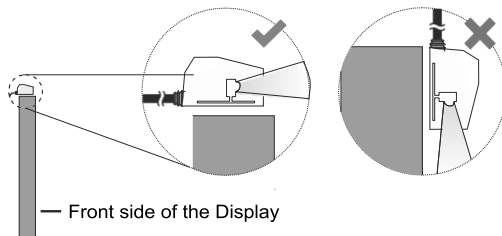

Depending on the model, your Display may have a built-in IR receiver on its cabinet. This IR receiver will not function if the external IR receiver is connected to the Display. Disconnect the external IR receiver if you want to use the built-in IR receiver again.

Turning the Display On/Off

Connect power

IMPORTANT: The Display is designed to operate on 110-240V AC, 50/60 Hz socket.

After unpacking, allow the Display to reach the ambient room temperature before you connect it to the mains. Plug the power cord into the mains socket outlet.

For models with detachable power cord

Plug one end (female connector - C13) of the supplied detachable power cord into the power cord inlet (AC IN) on the rear side of the TV. Then plug the other end of the power cord into the mains socket outlet.

Turn on the power switch on the Display - position "1" . The Display will switch into standby mode and the power LED will light up.

To switch on the Display

If the Display is in standby mode or quick standby mode, the power LED lights up. To switch on the Display either press the **Standby** button on the remote control or press the centre of the joystick in and hold it down for a few seconds. The Display will then switch on.

To switch the Display into standby mode

In order to switch the Display into standby mode press and hold the **Standby** button on the remote control. **Power off** dialogue will appear on the screen. Highlight **OK** and press the **OK** button. The Display will switch into standby mode.

To switch the Display into quick standby mode

In order to switch the Display into quick standby mode either press the **Standby** button on the remote control or press the centre of the joystick in and hold it down for a few seconds (while Home Screen is displayed). Press the button again to go back to operating mode.

Note: If the **Power Mode** option (to be found in the **Display Settings > Signage Settings > Power Up Settings** menu) is enabled (**Reactive mode**), the Display will switch into standby mode when the **Standby** button is pressed.

To switch off the Display

Turn off the power switch on the Display - position "2" (1 2). The Display will switch off. To power down the Display completely, unplug the power cord from the mains socket.

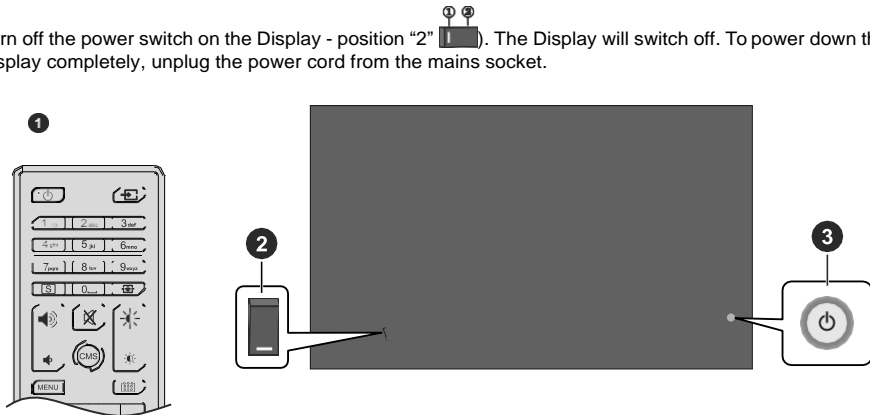

1. Standby Button
2. Power Switch (*)
3. Joystick

(*) The location of the power switch may differ depending on the model

| Power LED Status | Status of the Display |
|------------------|--|
| Not lit | Power on (operating mode) |
| Lit | Power off (standby mode, quick standby mode) |
| Flashing (slow) | Turning on or off |
| Flashing (fast) | Software update |

Remote Control

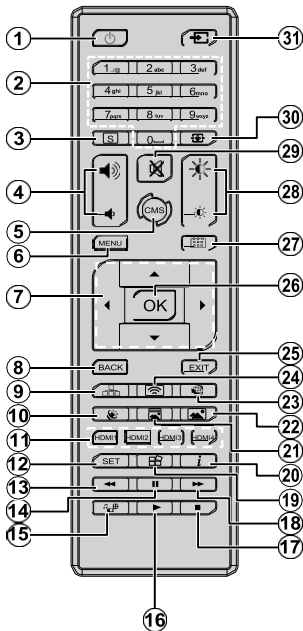

Inserting the Batteries into the Remote

Remove the screw that secures the battery compartment cover on the back side of the remote control first. Insert two 1.5V - size **AAA** batteries. Make sure the (+) and (-) signs match (observe correct polarity). Do not mix old and new batteries. Replace only with same or equivalent type. Place the cover back on. Then secure the cover again with the screw.

Standby Button

Press and hold the **Standby** button on the remote control. **Power off** dialogue will appear on the screen. Highlight **OK** and press the **OK** button. The Display will switch into standby mode. Press briefly and release to switch the Display into quick standby mode or to switch on the Display when in quick standby or standby mode.

1. **Standby:** Switches On / Off the Display
2. **Numeric buttons:** Enters a number or a letter in the text box on the screen
3. **Signage:** Displays Signage Settings menu
4. **Volume +/-:** Increases or decreases the volume
5. **CMS:** Launches on board ClevertouchLive signage application. Scan (QR code we have provided on the outer box) or visit <https://gettingstarted.clevertouch.com/cm-getting-started/>
6. **Menu:** Opens the **Display Settings** menu
7. **Directional buttons:** Helps navigate menus, content, etc.
8. **Back/Return:** Returns to previous screen
9. **Network:** Displays **Network/Internet Settings** menu
10. **Sound:** Displays **Sound** menu
11. **HDMI Buttons:** Switches to the selected HDMI input source
12. **SET:** No function
13. **Rewind:** Moves frames backwards in media such as movies
14. **Pause:** Pauses the media being played
15. **Media Player:** Launches the media player application
16. **Play:** Starts to play selected media
17. **Stop:** Stops the media being played
18. **Fast forward:** Moves frames forward in media such as movies
19. **Freeze:** Freezes display content
20. **Info:** Displays information about on-screen content
21. **Picture Mode:** Cycles between picture modes
22. **Picture:** Displays **Picture** menu
23. **Internet:** Launches the open browser application
24. **Wireless Display:** Launches AirServer application)
25. **Exit:** Closes and exits from displayed menus or returns to previous screen
26. **OK:** Confirms user selections
27. **Scheduler:** Displays Scheduler Settings menu
28. **Brightness +/-:** Increases or decreases the brightness of the screen
29. **Mute:** Completely turns off the volume of the Display
30. **Picture Zoom:** Changes the aspect ratio of the screen
31. **Source:** Shows all available content sources-General Use

Use the remote control when navigating through the menus and performing initial setup process.

Operation with the Remote Control

Press the **Back/Return** or **Exit** button to display or return to the Home Screen. You can navigate through the elements situated in the centre of the Home Screen using the remote control buttons. Press the Right directional button first to start navigating on the Home Screen with the remote. Press the **Menu** button to display the **Display Settings** menu. Use the directional buttons to move the focus, proceed, adjust some settings and press **OK** to make selections in order to make changes, set your preferences, enter a sub-menu, launch an application, etc. Press the **Back/Return** or **Exit** button to return to the previous menu screen or step, close a menu or exit an application, etc.

Input Selection

Once you have connected external systems to your Display, you can switch to different input sources. Press the **Source** button on your remote control. Use the directional buttons to highlight a source option and press the **OK** button to switch to that source. You can also use the dedicated HDMI buttons on your remote (depends on the model) to switch directly to the selected HDMI input.

Adjusting the Volume and Brightness

You can adjust the volume by using the **Volume +/-** buttons and the brightness by using the **Brightness +/-** buttons on the remote.

Note: Adjusting the brightness will not affect the picture on the launcher menu.

You can also adjust the brightness using the **Brightness** option in the **Display Settings > Picture** menu. Press the **Menu** button on the remote to display the **Display Settings** menu.

Initial Setup

When turned on for the first time, initial setup should be performed. Follow the on-screen instructions to setup your Display. The installation wizard will guide you through the setup process. Use the directional buttons and the **OK** button on the remote to select, set, confirm and proceed. You can use the **Back** button to go back to the previous steps and change your selections.

1. Language

The language selection options will be listed on the screen. Select the desired language from the list and press **OK** to continue.

2. Country

In the next step select your country from the list and press **OK** to continue.

3. Login

You will be asked to define a PIN at this point. Enter a PIN twice for confirmation using the virtual keyboard and then highlight **Continue** and press **OK**. You have

to enter this PIN if you are asked to enter a PIN for any menu operation later. To skip this step highlight **Skip Pin** and press **OK**.

4. Signage Settings

The **Signage Settings** menu will be displayed next. The **SetID**, **OSD Orientation**, and **NTP server** options can be configured using this menu. The **Model name**, **Serial number**, and **Software version** options are for information only. You can save the model information data of the Display to a connected USB storage device using the **Save model information** option. You can also copy database files from a connected USB storage device to the Display using the **Clone from USB** option. Refer to the **Signage Settings** section for more information on the options of this menu. After the settings are completed, highlight **Next** and press **OK** to continue.

5. Auto Launch

In this step you can set your Auto Launch preference for the Display. **Disabled**, **CMS**, **Open Browser**, **Select Source**, and **Select Application** options will be available. This is set to Disabled by default. In this case, the Display will open with the Home Screen and then launch AirServer and ClevertouchLive. For the **Select Source** and **Select Application** options you will have to set the available source or application of your choice. You can change your preference any time later using the **Auto Launch** option in the **Display Settings > Signage Settings > Power Up Settings** menu.

6. Display Operation Mode

The **Display Operation Mode** selection screen will be displayed next. For normal operation set the **Power Mode to Reactive**. Set to **Eco** for an energy-efficient operation. In this mode your Display's settings will be configured to reduce the energy consumption. Note that, in **Eco** mode the UART/LAN Commands will not work when the Display is in standby mode. Highlight **Next** and press **OK** to continue.

When the initial setup is completed Home Screen will be displayed. You can repeat the initial setup process and reset the Display's settings to the factory defaults anytime using the **First time installation** option in the **Display Settings > Signage Settings** menu. You can access the **Display Settings** menu by pressing the **Menu** button on the remote.

Note: You will be asked to enter the PIN to perform initial setup. If you didn't define a PIN during the initial setup, you can use the default PIN. Default PIN is set to 0000.

Home Screen

After the initial setup, the Display will open with the Home Screen. You can go to the **Display Settings > Signage Settings > Power Up Settings** menu to change the **Auto Launch** setting. If it is set to **Disabled**, the Display will always open with the Home

Screen. Press the **Back/Return** or **Exit** button to display or return to the Home Screen.

Following options will be available on the Home Screen:

- **HTML5 CMS Launcher:** Activate the CMS launcher or configure its settings using the related options. Refer to the **HTML5 CMS LAUNCHER** section for more information
- **Media Player:** Launches the media player application
- **Signage Settings:** Displays the **Signage Settings** menu
- **Applications:** Displays all applications installed on the Display

Display Settings Menu Content

You can configure the settings of your Display using the **Display Settings** menu. In order to access this menu, press the **Menu** button on the remote. Available options will be listed.

Note that some options in the **Display Settings** menu may not be available depending on the model of your Display and its features.

Picture

Picture Mode: Set the picture mode to suit your preference or requirements. Picture mode can be set to one of these options: **Game**, **Sports**, **Signage**, **Natural**, and **Text**.

Some of the picture settings will be adjusted according to the selected picture mode.

Energy Saving: Set your preference for energy saving. If set to **Eco** the Display will adjust the energy consumption accordingly. Set to **Off** to turn this setting off. Some other picture settings may not be changed if this option is set to **Eco**.

When the Display is not in use, you can switch off or disconnect the Display from the mains plug to reduce or cut the energy consumption.

Contrast: Adjust the contrast value of the screen.

Brightness: Adjust the brightness value of the screen.

Sharpness: Adjust the sharpness value for the objects displayed on the screen.

Colour: Adjust the colour saturation value of the screen.

Backlight: Adjust the backlight level of the screen manually. This item will not be available if the **Energy Saving** option is set to **Eco**.

Picture Zoom: Set the aspect ratio of the screen. To make the image fit the screen exactly, you can select one of the predefined options according to your preference.

Note: It is recommended to set the **Picture Zoom** option to **Auto**, if the Display's OSD Orientation is in one of the portrait modes. Otherwise, the picture may look stretched-out.

Advanced Settings

Dynamic Contrast: Set your preference for the dynamic contrast ratio setting. **High**, **Medium**, **Low**, and **Off** options will be available.

Microdimming: Set your micro dimming preference. **High**, **Medium**, **Low**, and **Off** options will be available. While this feature is active, it will enhance contrast locally for each defined zone.

Colour Temperature: Set your colour temperature preference. **Normal (9300K)**, **Warm**, **Cold**, and **User** options will be available.

Gamma Slider: Adjust the light and dark balance manually.

Noise Reduction: Set your preference for noise reducing functionality. **High**, **Medium**, **Low**, and **Off** options will be available.

Colour Shift: Adjust the colour tone manually.

Film Mode: It is the function for 3:2 or 2:2 cadence detection for 24 fps film content and improves the side effects (like interlacing effect or judder) which are caused by these pull down methods. Set your Film Mode preference as **Auto** or turn it off by setting to **Off**.

HDMI RGB Range: This setting should be adjusted according to input RGB signal range on HDMI source. It can be limited range (16-235) or full range (0-255). Set your HDMI RGB range preference. **Auto**, **Full**, and **Limit** options will be available.

Reset: Reset the video settings to factory default settings.

Note: Adjusting some of the settings may not affect the picture on the launcher menu.

Sound

Speakers: To hear the Display audio from the connected compatible audio device set to **External audio system**. Set to **TV Speakers** to use the speakers of your Display for sound output.

Dolby audio processing: With Dolby Audio Processing, you can improve the sound quality of your Display. Press **OK** to see the options and set.

Sound mode: Highlight the **Sound mode** option and press **OK** to see the preset sound modes. **Smart**, **Music**, **Movie**, and **News** options will be available. Highlight the option you prefer and press **OK** to set.

Balance: Adjust the left and right volume balance for speakers and headphones.

Digital Output: Set the digital sound output preference. **PCM**, **Bypass**, and **Auto** options will be available. Highlight the option you prefer and press **OK** to set.

Note: This option should be set to **PCM** instead of **Auto**, if the connected external audio device does not support **DD**. Otherwise, no sound will be heard from the connected device.

AVL: With this option, you can set the Display to automatically level out sudden volume differences. Typically at the beginning of adverts or when you are switching sources. Turn this option on/off by pressing **OK**.

HDMI/ARC latency: Adjust the delay value for HDMI/ARC.

Audio Output Latency: Adjust the delay value for SPDIF.

Reset: Reset the sound settings to factory default settings.

IP settings: Configure your Display's IP settings.

Signage Settings

Device Info

Display device information menu options.

Set ID: Sets the device ID. You can set a number using the virtual keyboard in order to identify your Display.

Software Version: Displays current software version. Press **OK** to open the update centre. In addition to the current software version, the last update date information can be found here. The **CHECK UPDATE** option will be highlighted. Press **OK** to start a manual search for a software update. To do this, your Display should be connected to the Internet. If any update is found, you can download and install the new software using the related options. Follow the on-screen instructions to complete the process.

Serial Number: Displays serial number of the Display. (Cannot be changed by the user)

Model Name: Displays model name of the Display. (Cannot be changed by the user)

Save Model Information: Copies the model information data of the Display to a connected USB device.

Display Life Time: Displays the lifetime of the Display in hours.

Controls

OSD Orientation: Sets the OSD (On Screen Display) rotation of your Display. **Landscape**, **Portrait1**, **Portrait2**.

Pixel shift: Enables or disables pixel shifting. This option can be used to avoid image retention (after image effects) that can occur when displaying fixed patterns or still images for long periods of time. If enabled, the picture and OSD (On-Screen Display) will be shifted at specified time intervals.

No Signal: Sets the behavior preference of the Display, when no signal is detected from the currently set input source. **Failover** and **Input Search** options are available.

If **Failover** is selected the Display checks the connected USB device for available files to play. If no playable files are available or there is no USB device connected to the Display, the No Signal Image will be displayed. If there isn't any No Signal Image available, No Signal OSD will be displayed on the screen. The setting of the **USB Auto Play** option in the **Display Settings > System Settings > More** menu is not important, in Failover mode it will function anyway.

If **Input Search** is selected, available input sources will be listed. Highlight the options you want and press

Network & Internet

You can configure your Display's network settings using the options of this menu.

Wi-Fi: Turn the wireless LAN (WLAN) function on and off. Highlight and press **OK** to turn this function on and off.

Available networks

When the WLAN function is turned on, a few available wireless networks will be listed. Highlight **See all** and press **OK** to see all networks. Select one and press **OK** to connect. You may be asked to enter a password to connect to the selected network, in case the network is password protected.

Other Options

Add new network: Add networks with hidden SSID's (network name). You can use this option in order to connect to the hidden networks by entering their names manually. This item will not be available if the **Wi-Fi** option is not turned on.

Networked Standby Mode: This is a standard that allows a device to be turned on or woken up by a network message when it is in standby mode. Highlight and press **OK** to turn this function on and off. Refer to **Networked Standby Mode** section for more information.

Ethernet

Under the **Ethernet** caption, you can see the LAN status (as **Connected - Not connected**) and also MAC/IP addresses if connected. You can also set a proxy server and change the IP settings using the related options.

Connected/Not connected: Displays the status of the connection (via Ethernet), IP and MAC addresses.

Proxy settings: Set a HTTP proxy for browser manually. This proxy may not be used by other apps.

OK to select. The Display will search all selected input sources consecutively to find signal. If no signal is detected from other available sources, the Display will turn off automatically after completing a cycle.

How to install No Signal Image

Install the file you want to use onto the root directory of any USB storage device and name it as "NoSignalImage.png". Connect the USB storage device to the Display. Highlight the **USB Operations** option in the **Display Settings>Signage Settings>USB** menu and press **OK**.

No Signal Delay: Sets a delay value to the 'No Signal' preferences when the Display is in No Signal state. After the set delay time has expired 'No Signal' preferences will be applied.

No Signal Power Off: When enabled the Display will turn itself off after a specified period of time (defined in the **No Signal Timer** option), if no signal is received from the selected source.

This feature will only work if all of the following circumstances occur:

- **No Signal** option is set to **Failover**.
- USB device is not connected to the Display / USB device is connected but there are no playable files installed on the USB device.

No Signal Timer: You can define a shut-off timer for the Display using this option. When the Display is in No Signal state and No Signal OSD is displayed on the screen, it will go into standby mode after the time set here has expired.

Panel Lock: Set to **On** to prohibit the use of the button/s on the Display.

RCU Inhibit: Set to **On** to inhibit the use of the remote. Remote control will function in standby mode independently from the setting of this option.

To turn this option off and be able to use the remote again, press the **MENU/M-1-9-7-3-Back/Return** buttons on the remote consecutively. The **Signage Settings** menu will appear. Enter the **Controls** menu and set this option to **Off**.

UART0: Select ASCII/HEX protocol for UART 0. Default value is ASCII. There is no need to restart the Display after selection in order to work with the protocols correctly. If the selection is changed, the latest selected protocol will be preserved and started when the Display is booted up.

Note that ASCII/HEX selection is not working while debug logs are enabled. If it is wrongly changed to HEX while debug logs are enabled, revert the selection to ASCII and reboot the Display in order to correct the debug logs and the ASCII protocol behaviour.

Also note that HEX protocol will work with the baud rate value 19200 for UART 0.

Also note that HEX protocol will work with the baud rate value 19200 for UART 0.

UART1: Select ASCII/HEX protocol for UART 1. Default value is HEX. There is no need to restart the Display after selection in order to work with the protocols correctly. If the selection is changed, the latest selected protocol will be preserved and started when the Display is booted up.

Note that ASCII/HEX selection is always working as expected. It does not matter if the debug logs are enabled or not.

Also note that HEX protocol will work with the baud rate value 9600 for UART1

Menu Lock: You can block the usage of the menu button on the remote by setting this item as **All menus**. When you press the **Menu** or **Signage** button, or highlight the **Signage Settings** on the Home Screen and press **OK**, you will be asked to enter the PIN that you have defined during the initial setup process. If you didn't define a PIN during the initial setup, you can use the default PIN. Default PIN is set to **0000**. Set to **Off** to disable this function.

Auto Source Switch: If this option is enabled the Display will switch to the currently active HDMI source automatically when a device is connected to the Display through the HDMI1 or HDMI2 input socket. Set to **Enabled** to enable this feature.

When the HDMI source is removed the Display will switch to other active HDMI source. If there isn't any other device connected to the Display and the HDMI WakeUP option for the related HDMI source is enabled the Display will switch into the standby mode.

There is also a 3-second restriction for the successive connected HDMI sources. This means, second HDMI device must be plugged in 3 seconds after the first HDMI device is plugged in.

Note: This feature applies for HDMI1 and HDMI2 input sockets only. Refer to the **General View** section to see the HDMI inputs.

Bluetooth: Switches on or off the Bluetooth functionality. Set to **Enabled** to enable this feature.

Power Up Settings

Power Up Mode: Configures the power up mode preference. **Always On**, **Standby**, and **Last State** options are available.

Power Mode: If this feature is enabled the Display can be turned on again with the RS232 and LAN commands if it is turned off through it. Press **OK** to enable or disable the feature.

Enabled - Reactive mode

Disabled - Eco mode

Power On Delay: Sets a delay value at power on. This value can be set from 0 to 2000 ms in steps of 100 ms. The Display will turn on after the set delay time has expired.

Auto Launch: Configures the auto launch preference. **Disabled, CMS, Open Browser, Vsign Lite, Select Source,** and **Select Application** options are available.

HDMI Wake Up Enabled: If this option is enabled, the Display will turn on with the HDMI1 input source, when it is switched on. This feature works based on HDMI 5V signal. When this signal is active the Display wakes up and when the signal is inactive the Display shuts down. You can enable or disable this option by pressing **OK**. In order to use this feature in conjunction with the Auto Source Switch feature it is recommended to enable the **Auto Source Switch** option in the **Signage>Controls** menu.

If any Scheduler is set this option will be inactive and can not be set as **Enabled**.

Note: This feature may not be available depending on the model of your Display.

USB

Clone to USB: Copies the database files from the Display to a connected USB device.

Clone from USB: Copies the database files from a connected USB device to the Display.

USB Operations: Highlight and press **OK** to perform USB operations.

USB Information: Press **OK** to open the **USB Information** menu screen. Current total space and free space information of the connected USB device will be displayed. You can also format the connected USB device as device storage using the **Format Disk** option in this menu (FAT32 format only) to extend the storage capacity of your Display. After doing this, that device will only be usable with the Display.

IMPORTANT: Formatting your USB storage device will erase ALL the data on it and its file system will be converted to FAT32.

USB Option: Set to **Off** to disable the USB ports on the Display. You can also set this option to **5V** to provide 5 volts power over USB. In this case it will still not be available to browse the USB content via the Media Player feature of the Display.

USB resume play: Press **OK** to enable or disable the feature. When enabled, the media player will be able to resume playing the most recently played file from the position where it was stopped last time. When disabled, the media player will start playing the file from the beginning.

Note: The resume play function status is retained until the Display is turned off (standby mode) or the USB memory device is taken out.

Safely Remove: You can use this option to remove the devices connected to the USB inputs of the Display safely. Highlight this option and press **OK**. Wait for the message to be displayed on the screen and then remove your device. Failure to do so, may cause

problems when you connect your USB device to other devices and you might have to format your USB device.

OPS Settings

Press **OK** to open the **OPS Settings** menu screen. This menu cannot be displayed if the OPS module is not plugged in.

OPS Status: Displays whether the OPS module is on or off. Allows the change of status via soft PSON signal (0.5s).

OPS Power: Highlight and press **OK** to turn the OPS module on or off.

Power Down: Turns the OPS off via hard PSON signal (5s).

Boot Signal: Enables or disables sending of a PSON signal. The Display checks the status signal of the OPS at bootup in order to turn it on by sending a PSON signal if it is off. Some OPS's send incorrect information on their status during the bootup of the Display, so they seem to be on even though they are off. For such non-standard OPS's, this option must be enabled. In this case, a PSON signal will be sent for the OPS regardless of the received status information at bootup.

Recovery Mode: When this option is enabled and OPS is on, if there is no video for 10 seconds it resets hotplug. If there is no video available after 30 seconds it reboots OPS.

OPS Always On: When this option is enabled, the **Power Mode** option in the **Display Settings > Signage Settings > Power Up Settings** menu will be forced to enabled (**Reactive** mode) and greyed out in the menu and OPS will not be set to standby.

Scheduler Settings

Using the scheduler options you can set the Display to turn on automatically at defined time intervals with the defined input source setting on the desired days of the week. Press **OK** to open the **Scheduler Settings** menu screen. You can set up to 4 different plans.

Highlight the desired plan option and press **OK** to set. Now you will be able to define a time for the Display to be turned on automatically. Highlight the related option and press the **OK** button, then use the directional and numeric buttons on the remote or the virtual remote to set a time. Highlight **OK** and press the **OK** button again when you are done.

Perform the same steps to set a time for the Display to turn off.

Next, select the week day/s for your plan to be activated. Highlight the desired day/s and press **OK** to check. Highlight and press **OK** a second time to uncheck a box. The plan will be active on the checked days of the week.

Then define a source for your plan. Highlight the related option and press the **OK** button, then set as desired using the Up/Down directional buttons and the **OK** button. If the **Last Source** option is selected, the input source will not be changed at the power-up. If the **USB** option is selected, the media files on the connected USB device will be automatically played back as explained in the **USB Auto Play Feature** section.

You can also set a backlight value for your plan. Highlight the backlight slider and set using the Left/Right directional buttons. Mind that, in case you set only the backlight slider, the display will not be turned on or off, only the backlight values will be changed at defined time interval. If the source option is set to **Last Source**, the backlight settings will be applied to all sources, otherwise the settings will be applied to the selected source only.

Highlight **Save** on the plan setting screen and press **OK** to save settings when complete.

Link Options

Press **OK** to open the **Link Options** menu screen. Current **Start url** and **Settings url** links will be displayed. These items are for information only and not selectable. Refer to the **Changing the Start and Settings URL**'s section for information on setting these links. The **Open browser initial page** and **NTP server** link preferences can be configured using the related options. Highlight the option you want to configure and press **OK**.

Open browser initial page: Sets the initial page link for the open browser.

NTP server: Sets the NTP server link.

Start url: Displays the Start URL link.

Settings url: Displays the Settings URL link.

Volume settings

VolumeLimit: Sets the maximum value of the volume.

VolumeLimit (Headphone): Sets the maximum value of the headphone volume.

Startup Volume Enable: Enables or disables the use of startup volume values which are set in the **Startup Volume Value** and **Startup Volume Value (Headphone)** menu items. If this option is disabled, these menu items will be unavailable to be set. Press **OK** to enable or disable the feature.

Startup Volume Value: Sets the startup value of the volume.

Startup Volume Value (Headphone): Sets the startup value of the headphone volume.

Fixed Volume Enable: Enables or disables the use of fixed volume value which is set in the **Fixed Volume Value** menu item. Press **OK** to enable or

disable the feature.

Fixed Volume Value: Sets the value of the volume to be fixed.

Headphone Direct Volume: Enables or disables the control of the headphone volume through remote control. When this feature is enabled, volume control buttons will not change the Display's main sound. You can change the sound of the Display using the Left/Right directional buttons of the remote control. Press **OK** to enable or disable the feature.

Reset to Default Values

Reset: Highlight this option and press the **OK** button on the remote to return the signage menu settings to factory defaults.

Video Wall Settings

Reset: Resets the settings to factory defaults.

First time installation

Highlight this option and press **OK** to repeat the initial setup process and reset the Display's settings to the factory defaults.

System Settings

Language: Set your OSD menu language preference.

Date & time: Set the date and time options of your Display.

Automatic date & time: You can set your Display to automatically update the time and date data over the network. Turn this option off, if you want to manually set the date and time.

Set date: Set the date manually.

Set time: Set the time manually.

Set time zone: Set the time zone.

Use 24-hour format: Turn the 24-hour format on or off.

Sources: Enable or disable selected source options. There will be **Disabled**, **Enabled**, and **Enhanced** options available for HDMI sources, if your Display supports Ultra HD. The **Enabled** and **Enhanced** options are affecting the colour settings of the selected HDMI source. To be able to watch 4K images from an HDMI source related source setting should be set to **Enhanced** if the connected device is HDMI 2.0 compatible. Set to **Enabled** if the connected device is HDMI 1.4 compatible. Set accordingly or disable the related HDMI source by setting to **Disabled**.

Note: HDMI cables which are longer than 5 metres and which are not HDMI certified can cause display problems. We recommend using a certified Premium High-Speed HDMI Cable. Source device, connection cable quality and other HDMI equipments used may affect performance.

Please refer to → <https://www.hdmi.org/resource/cables> (for finding the right cable)

More

Menu Timeout: Set your idle timeout duration preference for the menus.

Standby Mode Led: Enable or disable the functionality of the standby mode LED. If set to **Off** the standby mode LED will not light up when the Display is in standby mode.

Software Upgrade: Ensure that your Display has the latest software. Press **OK** to see the current software version and last update time. The **CHECK UPDATE** option will be highlighted. You can start a manual search for an update by pressing **OK**. To do this, your Display should be connected to the Internet. If any update is found, you can download and install the new software using the related options. Follow the on-screen instructions to complete the process.

Country: The country that was selected during the initial setup process will be shown.

Auto Display OFF: Set your time preference for the Display to automatically go into standby mode when not being operated. This option can be set from 1 to 8 hours in steps of 1 hour. You can also disable this option by setting to **Off**.

CEC: Enable or disable the CEC functionality. Highlight the option of your choice and press **OK** to set.

CEC Auto Power On: This function allows the connected HDMI-CEC compatible device to turn on the Display and switch to its input source automatically. Highlight the option of your choice and press **OK** to set.

USB Auto Play: Using this option you can set your Display to start playing the media content installed on a removable device automatically. Refer to **USB Auto Play Feature** section for detailed information.

Device Preferences

About: Check for system updates, change the device name, restart the Display and view system information such as network addresses, serial numbers, versions, etc. You can also view legal information here.

Date & Time: Set the date and time options of your Display. You can set your Display to automatically update the time and date data over the network. Set corresponding to your environment and preference. Disable by setting as **Off** if you want to manually change the date or time. Then set the date, time, time zone and hour format options.

Language: Set your language preference.

Keyboard: Select your keyboard type, configure re- mote controller input method preferences, and manage keyboard settings.

Sound

System Sounds: System sound is the sound played when navigating or selecting an item on the Display screen. Highlight this option and press **OK** to turn this function on or off.

Surround Sound: Select your preference for the surround sound feature. Highlight **Select formats** and press **OK**. **Auto**, **None**, and **Manual** options will be available. Highlight the option you prefer and press **OK** to set.

Storage: View the total storage space status of the Display and connected devices if available. To see detailed information on the usage details highlight and press **OK**. There will also be options for ejecting and setting up the connected USB storage devices as device storage.

Eject: To keep your content safe, eject your USB storage device before you unplug it from your Display.

Erase & format (Set up) as device storage: You can use the connected USB storage device to extend the storage capacity of your Display. After doing this, that device will only be usable with the Display. Follow the on-screen instructions and read the information displayed on the screen before proceeding.

Note: *Formatting the connected storage device will erase all data installed on it. Back up the files that you want to keep before you proceed with formatting the device.*

Erase & format (Set up) as removable storage: If you did priorly format your USB storage device as device storage, it will only be usable with your Display. You can use this option to format it again in order to use it with other devices. Before proceeding with the formatting, you may consider backing up the data on your device to your Display's internal storage or to another USB storage device using the **Back up apps** option. Otherwise, some apps may not work properly after formatting. Follow the on-screen instructions and read the information displayed on the screen before proceeding.

Note: *Formatting the connected storage device will erase all data installed on it. Back up the files that you want to keep before you proceed with formatting the device.*

Screen Saver: Set the screensaver and sleep mode options for your Display. You can choose a screensaver, set wait time for the screensaver, set when the Display goes into sleep mode or start the screensaver mode.

Location: You can allow the use of the wireless connection to estimate the location, see the recent location requests and allow or restrict the listed apps to use your location information.

Security & restrictions: Using the options of this menu;

- You can allow or restrict installation of apps from sources other than the Google Play Store.
- Set the TV to disallow or warn before installation of apps that may cause harm.

Accessibility: Configure **Captions**, **Text to speech**, **Accessibility shortcut** settings and/or turn **High contrast text** on/off. Some of the caption settings may not be applied.

Restart: A confirmation message will be displayed, select **Restart** to proceed with restarting. The Display will switch off/on first. Select **Cancel** to exit.

Reset: Reset all Display settings to the factory defaults. Highlight **Reset** and press **OK**. A confirmation message will be displayed, select **Reset** to proceed with resetting. The Display will switch off/on first and the initial setup will start. Select **Cancel** to exit.

Installing 3rd party applications

Follow the below mentioned steps in order to install a third party application.

- Copy the file with the extension “.apk” onto a FAT formatted USB storage device
- Connect the USB storage device to one of the USB inputs on the Display.
- Launch the **AppInstaller** app from the **Applications** menu on the Home Screen. Highlight your connected USB storage device on the next dialogue and press **OK** to search the content for apk files. Highlight one of the found files and press **OK**. Your permission will be asked. Highlight **INSTALL** and press **OK** again to proceed.
- You can access the installed applications from the Applications menu on the Home Screen.

Note: *Third party applications support is limited. Some functions of the application or properly launch may be affected as not being coded according to required Android platform. Download processes via the open browser are not supported.*

Connectivity

To configure wired and wireless settings you should access the **Display Settings > Network & Internet** menu. Press the **Menu** button on the remote to view the **Display Settings** menu.

To Connect to a Wired Network

There is an Ethernet socket on the rear side of your Display. Connect your Display to your modem/router via this Ethernet socket using an Ethernet cable. Refer to the **General View** section on the first pages of this manual to see the location of the socket.

The status of the Internet connection under the **Ethernet** caption in the **Network & Internet** menu will read 'Connected'. The MAC and IP addresses will also be displayed under this caption.

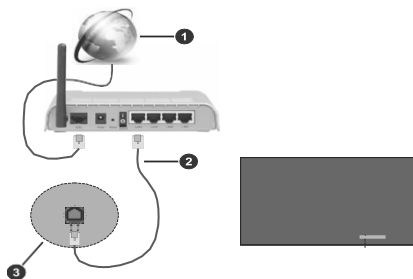

1. Broadband ISP connection
2. Ethernet (LAN) cable
3. Ethernet (LAN) input (on the rear side of the Display)

To Connect to a Wireless Network

A wireless LAN modem/router is required to connect the Display to a wireless network. If the Display is connected to a wired network, unplug the Ethernet cable to allow wireless connection.

Highlight the **Wi-Fi** option in the **Network & Internet** menu and press **OK** to turn on the WLAN. Available networks will be listed. Select one and press **OK** to connect. You may be asked to enter a password to connect to the selected network, in case the network is password protected.

You can see the status of the connection under the name of your network. It will read 'Connected' if the connection is successful. Highlight your network under the **Available networks** caption in the **Network & Internet** menu and press **OK** to see the detailed information on the connection such as MAC and IP addresses. This way you can also access advanced settings for the wireless connection such as proxy and IP settings. You can also use the **Forget network** option here to delete the connected wireless network profile, so the Display will not connect to that network automatically if it is available when the WLAN option is turned on.

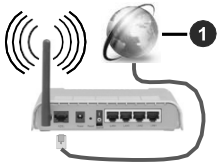

1. Broadband ISP connection

A network with hidden SSID (network name) can not be detected by other devices. If you want to connect to a network with hidden network name, highlight the **Add new network** option under the **Other options** caption and press **OK**. To connect to the network, enter its name, select the type of security and then enter the password if it is password-protected. You can also make your network's name visible by changing the settings via the modem's software.

A Wireless-N router (IEEE 802.11a/b/g/n/ac) with simultaneous 2.4 and 5 GHz bands is designed to increase bandwidth. These are optimised for smoother and faster HD video streaming, file transfers and wireless gaming.

The frequency and channel differ depending on the area.

The transmission speed differs depending on the distance and number of obstructions between the transmission products, the configuration of these products, the radio wave conditions, the line traffic and the products that you use. The transmission may also be cut off or may get disconnected depending on the radio wave conditions, DECT phones or any other WLAN 11b appliances. The standard values of the transmission speed are the theoretical maximum values for the wireless standards. They are not the actual speeds of data transmission.

The location where the transmission is most effective differs depending on the usage environment.

The Wireless feature of the Display supports 802.11 a,b,g,n & ac type modems. It is highly recommended that you should use the IEEE 802.11n communication protocol in order to avoid any possible problems while watching videos.

You must change your modem's SSID when there are any other modems around with the same SSID. You can encounter connection problems otherwise.

Use a wired connection if you experience problems with a wireless connection.

A stable connection speed is required to play back streaming content. Use an Ethernet connection if the wireless LAN speed is unstable.

Note: Android system allows only one network connection at a time. If the Display is connected to the network both wirelessly and via Ethernet (wired), the Ethernet connection will take priority. Since if this is the case, a WLAN connection can not be established. Unplug the Ethernet cable to allow wireless connection.

Network Standby Mode

Networked Standby Mode is a standby that allows a device to be turned on or woken up by a network message (magic packet). This message is sent to the device by a program executed on a remote device connected to the same local area network, such as a smartphone.

To enable this feature the **Networked Standby Mode** option in the **Network & Internet** menu and the **Power Mode** option in the **Display Settings>Signage Settings>Power Up Settings** menu should be enabled (**Power Mode - Reactive**). It is necessary that both the device, from which the network message will be sent to the Display, and the Display are connected to the same network. All devices must support magic packet on the system from Access Points to the device which sends the magic packet and the device which receives the magic packet to wake-up. You can use any Networked Standby Mode software available for the operating system of your device in order to send magic packets.

In order to use this feature the Display and the remote device should be connected at least once while the Display is on. If the Display is powered off, the connection should be re-established, the next time it is switched on. Otherwise this feature will be unavailable. This does not apply, when the Display is switched into the standby mode.

How to control functionality

- Enable the **Networked Standby Mode** feature from within the **Network & Internet** menu
- Connect your Display and the remote device, which will send the magic packets to the Display, to the same network
- Get the MAC address of your Display which will be needed in order to send magic packets. Refer to **Connectivity** section for information on how to get the MAC address
- Switch the Display into standby mode
- Send magic packets to the MAC address of your Display by using mobile phones, Linux or Windows computers

Your Display should wake up after receiving magic packets.

Airserver Wireless Mirroring

AirServer is a universal screen mirroring receiver enabling users to project their own content from PC, Google, Android and Apple devices.

AirServer works with the most popular apps such as YouTube.

AirServer is an application for streaming video and sound content by using Miracast, Googlecast and Airplay standard connectivity protocols. This feature provides the ability to use your Display as a wireless display device.

Note: *This feature can be used only if the source device supports this feature and is connected to the same network as the display screen. If you experience problems with the connection check if the operating system version you use supports this feature. There may be incompatibility problems with the operating system versions which are released after the production of this Display. Scanning and connecting processes differ according to the programme you use.*

The maximum supported resolution is 1920x1080. *Image quality may be affected by neighbouring wireless networks and your internet connection speed.*

APPS

You can access the applications installed on your Display from the **Applications** menu on the Home Screen. The Display will open with the Home Screen if the **Auto Launch** option (to be found in the **Display Settings > Signage Settings > Power Up Settings** menu) is set to **Disabled**. Press the **Back/Return** or **Exit** button to display or return to the Home Screen. Highlight **Applications** and press **OK**, then highlight an app and press **OK** to launch.

Notes:

Possible application dependent problems may be caused by the content service provider.

Third party internet services may change, be discontinued or restricted at any time.

Internet Browser

To use the internet browser enter the **Applications** menu on the Home Screen first. Then launch the **Vewd Browser** application. EULA (End User Licence Agreement) confirmation dialogue will be displayed. You can read the entire text using the Up and Down directional buttons. Highlight **Accept** and press **OK** to confirm and proceed.

In the initial screen of the browser, the thumbnails of the predefined (if any) links to web sites available will be displayed as **Speed Dial** options along with the **Edit Speed Dial** and the **Add to Speed Dial** options.

You can press the **Internet** button on the remote to open the internet browser. If the **Open browser initial page** link in the **Display Settings > Signage**

Settings > Link Options menu is defined, the browser will open on this page.

To navigate the web browser, use the directional buttons on the remote or a connected mouse. To see the browser options bar, move the cursor to the top of the page. **History**, **Tabs** and **Bookmarks** options and the browser bar which contains previous/next buttons, the refresh button, the address/search bar, the microphone (non-functional), the **Speed Dial** and the **Vewd** buttons are available.

To add a desired website to the **Speed Dial** list for quick access, move the cursor to the top of the page. The browser bar will appear. Highlight the **Speed Dial**  button and press the **OK** button. Then select **Add to Speed Dial** option and press the **OK** button. Fill in the blanks for **Name** and **Address**, highlight **OK** and press the **OK** button to add. Whilst you are on the site you wish to add to the **Speed Dial** list, highlight the **Vewd** button and press the **OK** button. Then highlight the **Add to Speed Dial** option in the submenu and press the **OK** button again. **Name** and **Address** will be filled automatically according to the site you are visiting. Highlight **OK** and press the **OK** button to add.

You can also use the **Vewd** menu options to manage the browser. Highlight the **Vewd** button and press the **OK** button to see available page specific and general options.

There are various ways to search or visit websites using the web browser.

Enter the address of a website(URL) into the search/address bar and highlight the **Go** button on the virtual keyboard and press the **OK** button to visit the site.

Enter keyword/s into the search/address bar and highlight the **Go** button on the virtual keyboard and press the **OK** button to start a search for the related websites.

Highlight a Speed Dial thumbnail and press the **OK** button to visit the related website.

Your Display is compatible with USB keyboard/mice. Plug your device into the USB input of your Display for easier and quicker navigation.

Some web pages include flash content. These are not supported by the browser.

Your Display does not support any download processes from the internet via the browser.

All sites on the internet might not be supported. According to the site; content problems may occur. In some circumstances video contents might not be able to be played.

Media Player

Highlight **Media Player** on the Home Screen and press **OK** to launch the app. You can also press the **Media Player** button on the remote for quick access. Select the media type on the main media player screen.

Image Files

Press **OK** to display the highlighted photo file. On the upper left and right of the screen some options will be available. Using these options you can sort or group the files, change the viewing style, start a slideshow, etc. You will also be able to select the files, then make the selected files available offline, share them via short- range wireless connection (depends on the model), rotate left/right or refresh the screen or access more settings using the related options.

When you start a slide show, all photo files in the current folder will be displayed in an infinite loop. Press the **OK** or **Return/Back** button to stop the slide show.

Music Files

You can use the tabs at the top of the screen to sort the files. Press **OK** to play back the highlighted music/ audio file. Now Playing screen will be displayed. You can use the options here to control the media.

The Media Control Buttons on the Now Playing Screen

Play List: Display the now playing playlist.

Shuffle: Highlight and press **OK** to turn the shuffle option on or off. When the shuffle mode is on, all of the music files in the current playlist are played in a random order.

Repeat: Highlight and press **OK** to turn on or off the repeating option for the playing file or all files in the current playlist. Press **OK** consecutively to change the functionality. All music files in the current list or the currently playing file will be repeatedly played back.

Pause/Play: Highlight and press **OK** to pause and resume the playback.

Start from beginning/Previous File: Highlight and press **OK** to start the playback from the beginning or switch to the previous file in the list.

Next File: Highlight and press **OK** to switch to the next file in the list.

Playback Progress Bar: Highlight and use Left/ Right directional buttons to fast forward or rewind the playback.

Video Files

Select the drive as **Local Disk** or the connected USB storage device. Highlight a video file and press **OK** to play it back. You can use the buttons on the

info bar to control the video playback, and configure the settings. The info bar will disappear after a certain period of time. Press **OK** to reveal the info bar again.

From USB Connection

IMPORTANT! Back up the files on your USB storage devices before connecting them to the Display. Manufacturer will not be responsible for any file damage or data loss. Certain types of USB devices (e.g. MP3 Players) or USB hard disk drives/ memory sticks may not be compatible with this Display.

You can view your photos, text documents or play your music and video files installed on a connected USB storage device on the Display. Plug in the USB storage device to one of the USB inputs on the Display.

On the main media player screen select the desired media type. Then, highlight a media file and press the **OK** button. Follow the on-screen instructions and see the related sections above for more information on other available button functions.

Note: Wait a little while before each plugging and unplugging as the player may still be reading files. It is recommended to use the **Safely Remove** option in the **Signage Settings > USB** menu or the **USB Safely Remove** option in the **File Manager** application. Failure to do so may cause physical damage to the USB player and the USB device itself. Do not pull out your drive while playing a file.

USB Auto Play Feature

This feature is used to start playing the media content installed on a removable device automatically. It uses the Media Player application. The media content types have different priorities in order to be played. The reducing priority order is as Photo and Video. That means, if there is Photo content in the root directory of the removable device, Media Player will play the Photos in a sequence (in file name order) instead of Video files. If not, it will be checked for Video content.

This feature will only work if all of the following circumstances occur:

- The USB device is plugged in.
- The **USB Auto Play** option is enabled. It can be found in the **Display Settings > System Settings**

> More menu.

CEC and CEC RS Passthrough

This function allows to control the CEC-enabled devices, that are connected through HDMI ports by using the remote control of the Display.

The **CEC** option in the **Display Settings > System Settings > More** menu should be set to **Enabled** at first. Press the **Source** button and select the HDMI input of the connected CEC device from the **Source** menu. When a new CEC source device is connected, it will be listed in the source menu with its own name instead of the connected HDMI port's name (such as DVD Player, Recorder 1, etc.).

The Display remote is automatically able to perform the main functions after the connected HDMI source has been selected. To terminate this operation and control the Display via the remote again, press and hold the "0-Zero" button on the remote control for 3 seconds.

You can disable the CEC functionality by setting the related option under the **Display Settings > System Settings > More** menu accordingly.

The Display also supports the ARC (Audio Return Channel) feature. This feature is an audio link meant to replace other cables between the Display and an audio system (A/V receiver or speaker system).

When ARC is active, the Display does not mute its other audio outputs automatically. You will need to decrease Display volume to zero manually if you wish to hear the ARC audio only (same as optical or co-axial digital audio outputs, availability depends on the model). If you want to change connected device's volume level, you should select that device from the source list. In that case volume control keys are directed to connected audio device.

System Audio Control

Allows an Audio Amplifier/Receiver to be used with the Display. The volume can be controlled using the remote control of the Display. To activate this feature set the **Speakers** option in the **Display Settings>Sound** menu to **External audio system**. The Display speakers will be muted and the sound of the watched source will be provided from the connected sound system.

Note: *The audio device should support System Audio Control feature and CEC option should be set to **Enabled**.*

Changing the start and settings URL's

- Create a file named "starturl.txt" or "settingsurl.txt" in the root directory of any USB storage device. Make sure that the extension is

"txt".

- Open this file with a text editor software such as Notepad.
- Write the desired URL (for example, www.starturl.com) in the file and save changes.
- Connect the USB storage device to the Display. Highlight the **USB Operations** option in the **Display Settings > Signage Settings > USB** menu and press **OK**.
- Switch the Display off and then switch it on again.

Note: *You can check if the Start URL or Settings URL have the desired link from the **Display Settings > Signage Settings > Link Options** menu.*

HTML5 CMS Launcher

The launcher locates the "index.html" file in the folder that is specially created for the CMS files on the Display's internal storage and opens it in the web browser.

For trouble-free operation of the CMS launcher, the storage permission should be enabled for the Vewd browser first. Press the **Menu** button and then the **3-2-9-1** buttons on the remote consecutively to access the hidden Android Settings menu. Enter the **Storage** category in the **Apps > App permissions** menu, highlight the option for the Vewd browser and press **OK** to enable.

Highlight **HTML5 CMS Launcher** on the Home Screen and press **OK**. The **Launcher** and **Settings** options will be available.

Launcher

You can activate the CMS launcher using this option.

Settings

You can install new CMS files using one of the two available options, or delete the previously set URL and installed CMS files.

Install from URL: The compressed CMS file is uploaded as a URL. Enter the URL of the file, highlight **OK** and press **OK**. The file will be downloaded and then extracted to a dedicated folder on the Display's internal storage.

Install from USB: The compressed CMS file is installed onto a USB storage device. The file should be named "cms.zip". Connect a USB storage device to the Display that contains the cms file, then highlight this option and press **OK**. The connected USB device will be checked for available files. The file will be downloaded and then extracted to a dedicated folder on the Display's internal storage.

Return to Factory Settings: The previously set URL and installed CMS files will be deleted.

HDMI out

The HDMI port located on the rear left side of the Display functions as an output port (upper HDMI port, HDMI Out). This port will not function as an input, thus no source devices should be connected to this port.

Only the content received from the HDMI1 input port located also on the rear left side of the Display (the one under the HDMI Out port) can be outputted from this port. The content received from other inputs, such as Display Port (depends on the model), can not be outputted. This is a default function and you can not disable/enable through any menu option. HDMI Out port will always function if a source device is connected to the HDMI1 input.

Real Time Clock (RTC)

Your Display has an RTC. It is used to maintain the real date and time information for a period of time if the energy supply is interrupted by separating the Display from the mains or by a power blackout. In this case the Display will use the date and time information stored in RTC.

- All time sources are able to override RTC date/time.
- Display tries to connect to the **NTP server** periodical- ly (6 hours after last update) to get the current date and time information. If the Display successfully gets this information from the NTP server, it updates itself and RTC with the received date and time information. If the NTP server update fails, the Display uses RTC time and date to update itself.
- The RTC battery provides power to the integrated real-time clock and the calendar. Without any external power source, RTC is able to function for a minimum of 14 days.
- If RTC is used as time source, manual date-time set is enabled from the **Date/Time** option in the **Display Settings > System Settings** menu.

Controlling with an External PC

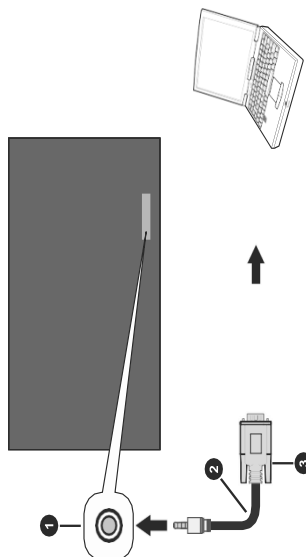

1. RS-232 Input Socket (3.5mm)
2. RS-232 to 3.5mm serial cable (commercially available)
3. To COM port
4. RS-232 to USB adapter
5. PC

You can control the Display from an external PC via RS-232 (COM port) or LAN (Ethernet port) on the PC. For instance, system source can be changed by RS-232 from remote computer. When a command is sent from the PC to the Display, the Display operates according to the received command and sends a response message to the PC.

Equipment/Tools

- RS-232 (3.5mm) to RS-232 (male) cable or LAN cable (connected via router)
- USB to RS-232 (female) adapter
- Notebook or PC which has USB or LAN port
- Installed program on remote PC to send commands

In general, the RS-232 commands are sent for operating the implemented functions via serial port and utility. A suitable utility can be used such as described below.

Connecting to the Display (RS232 port)

Run the software and select **Serial** as **Connection Type**. Enter the Display's serial port in the field **Serial Line** (in the following example it is COM4) and "115200" in the field **Speed**. Then click the **Open** button.

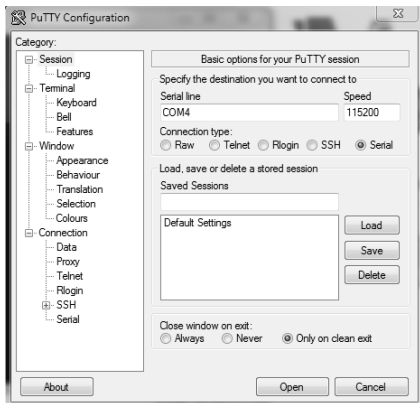
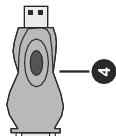

RS232/LAN Command Table

| ADMIN PANEL COMMANDS | | | |
|------------------------|---|--|--|
| Command | Description | Parameter | Return |
| TOF | Turn off panel | no parameter | #Display will be sent to Active Standby state. or #Display is in Active Standby state already! |
| RST | Restart | no parameter or int (wait seconds until Restart) | #Display will be restarted |
| STV | Sets panel Volume, parameter value will ve set for volume level | integer (volume level) | #Volume set level= ... |
| GTZ | Get Time Zone | no parameter | #Timezone is ... |
| CTZ | Change Time Zone. | integer (gmt value) | #Timezone setup SUCCEEDED |
| STL | Set panel Language | string-int (please look at abbreviations of languages) | #Language changed to ... or #Wrong language selection. |
| SMA | Set mac address Note: This command is not available for MB230 platform. Instead, set_mac_address command can be used. Note2: This command only changes mac address of wired interface. Note3: Reboot needed. | string-int (ex: eth0-00:09:df:86:34:25) | #SetMacAdress Successful #*FAILURE - Invalid mac address! #*FAILURE - Could not write MAC address! |
| get_mac_address | Get mac address | none | #*Hwaddr: mac_address - Sucesfull |
| GETMACADDRESS | Gets mac address of selected network interface | none | #*Hwaddr: <mac_address> - Sucesfull or #*Mac address could not be obtained |
| GETGPIO | Gets the GPIO's state | pin number(visit the GPIO List) | #*GPIO level is ... |
| SETGPIOLOW | Sets the GPIO's state to low | pin number(visit the GPIO List) | #*... is set to HIGH |
| SETGPIOHIGH | Gets the GPIO's state to high | pin number(visit the GPIO List) | #*... is set to LOW |

| | | | |
|---------------------|---|--|---------------------------------|
| SELECTSOURCE | Select source. | integer n (7 = HDMI1, 8 = HDMI2, 9 = HDMI3, 10 = HDMI4, 19 = DP, 20 = OPS, 26 = TYPE C) | ##*Select external source: ... |
| SSIP | Set static IP, Default Gateway and SubnetMask addresses (seperate addresses with "-" character) | string (ex: 192.168.0.15-10.0.90.5-255.255.255.0) | ##IP address setting Succesfull |

AUDIO COMMANDS

| Command | Description | Parameter | Return |
|-------------------|--|---|--|
| VOLUME | Set volume level. | integer n ($0 \leq n \leq 100$) | ##*set volume to n |
| GETVOLUME | Volume level information. | no parameter | ##*volume level is ... |
| VOLUMEUP | Increase Volume Level by 1 step (Until max volume) | no parameter | ##*volume LEVEL is increased to ... or ##*Volume level is at max value. You can not increase volume level further. Confirmed max volume level is ... |
| VOLUMEDOWN | Decrease Volume Level by 1 step | no parameter | ##*volume LEVEL is decreased to .. or ##*Volume level is at min value. You can not decrease volume level further |
| SETEQMODE | Set equalizer mode. | string n (Standart, Music, News, Theater, Game, Custom) | ##*setEQMode() set to n or ##*The above parameter should be one of Standard, Music, News, Theater, Game, Custom. |
| GETEQMODE | Get equalizer mode | no parameter | ##*the equalizer mode is n Note: Above n is one of Standart, Music, News, Theater, Game, Custom |
| GETMUTE | Get mute status. | no parameter | ##*MUTE OFF or ##*MUTE ON |
| SETMUTE | Toggle mute status. | no parameter | ##*MUTE OFF or ##*MUTE ON |
| SETBALANCE | Set balance value. | integer n ($-50 \leq n \leq 50$) | ##*set balance level to n or ##*invalid balance level entered |
| GETBALANCE | Get balance value. | no parameter | ##*balance level is ... |

| | | | |
|--------------------------|---------------------------|-----------------------------|--|
| SETDYNAMICBASS | Set dynamic bass state. | integer n (0 = off, 1 = on) | ##set dynamic bass state to n |
| GETDYNAMICBASS | Get dynamic bass state. | no parameter | ##the dynamic bass state is ... (0 = off, 1 = on) |
| SETBASSGAIN | Set bass gain | integer n (-6 <= n <= 6) | ##set bass gain to n or ##Incorrect sound system parameter entered |
| GETBASSGAIN | Get bass gain | no parameter | ##the bass gain level is n Note: Above n is -6 <= n <= 6 |
| SETSURROUNDSSOUND | Set surround sound state. | integer n (0 = off, 1 = on) | ##set surround sound state to n |
| SOUNDRESET | Reset sound settings | no parameter | ##reset all sound settings |

BROWSER COMMANDS

| Command | Description | Parameter | Return |
|-------------------------|--|--|---|
| OPENURL | Starts the given URL and returns web page load status directly. | string | ##URL : ... |
| GETURL | Gets URL of the current page if the portal is active. | no parameter | ##URL : ... |
| SETSETTINGSURL | Sets the browser settings URL | string | ##Setting URL is set |
| GETSETTINGSURL | Gets the browser settings URL | no parameter | ##Setting URL is ... |
| SETSTARTURL | Sets the start URL | string | ##Start URL is set |
| GETSTARTURL | Gets the start URL | no parameter | ##Start URL is ... |
| GETUSERAGENT | Gets portal user agent. | no parameter | ##Current UA : ... |
| CLEARCACHE | Clear browser cache/cookies (Private datas like web form) | no parameter | ##Browser cookies are cleared |
| CLEARBROWSERDATA | Clear browser data files like History, Bookmarks, Speed Dial and Configuration | no parameter | ##Browser data files are cleared |
| GETCMSSTATUS | Gets the CMS status | no parameter | ##Do cms status assignment with SETCMSSTATUS command or Returns the value of cms status |
| SETCMSSTATUS | Sets the CMS status | string parameter max. length of 255 characters | ##CMS status set to ... or ##NACK |

| | | | |
|------------------------|---|--|---|
| GETCMSPARAMS | Gets the CMS parameters | no parameter | ##Do cms param assignment with SETCMSPARAMS command. or Returns the value of cms params |
| SETCMSPARAMS | Sets the CMS parameters | string parameter max. length of 255 characters | ##CMS params set to ... or ##NACK |
| SETBROWSERDEBUG | Sets the browser debug mode | string n (n = ON, n = OFF) | Browser debug is enabled. Open the following url with any chromium-based desktop browser: chrome://inspect or Browser debug is disabled |
| SETBROWSECORS | Set browser cors status to enable disable web security flag | int n (n = 0,1) | ##Browser cors is enabled or ##Browser cors is disabled |
| GETBROWSECORS | Get browser cors status | no parameter | ##Browser cors is enabled or ##Browser cors is disabled |

FILE SYSTEM COMMANDS

| Command | Description | Parameter | Return |
|----------------------------|---------------------------------------|--|---|
| MP3PLAY | Play MP3 audio file. | string-integer n Example: MP3PLAY audio.mp3 | ##Playing audio : n |
| MP3GETPLAYING | Returns playing audio file. | no parameter | ##Playing /storage/2ECD-304C/audio.mp3 |
| VIDEOPLAY | Play Video file. | string-integer n Example: VIDEOPLAY video.mp4 | ##Playing video : n |
| VIDEOGETPLAYING | Returns playing video file. | no parameter | ##Playing /storage/2ECD-304C/video.mp4 |
| IMGSHOW | Show image file. | string-integer n Example: IMGSHOW picture.jpg | ##Playing video : n |
| IMAGEGETSHOWN | Returns shown image file. | no parameter | ##Showing / storage/2ECD-304C/ picture.jpg |
| GETDISKFORMAT STATE | Get format state of internal USB disk | no parameter | ##the disk is formatted. or ##the disk is not formatted. or ##No Internal USB is found. |

| | | | |
|-------------------|---------------------------------------|--------------|--|
| FORMATDISK | Format the internal USB disk as FAT32 | no parameter | #*formatting is succesful. or #*error while formatting. or #*No Internal USB is found. |
|-------------------|---------------------------------------|--------------|--|

GENERAL PANEL FUNCTIONS

| Command | Description | Parameter | Return |
|----------------------|---|---|---|
| Led | Turns the led on/off. (Used for setting the led status of current state) | integer n (0 = off, 1 = on) | #*Led is ON or #*Led is OFF |
| GETLED | Get led on/off state. (Used for getting the led status of current state) | no parameter | #*LED is on or #*LED is off |
| SETSTANDBYLED | Set Standby led status | string n (n = ON, n = OFF) | #*Standby Led is set to ON or #*Standby Led is set to OFF or #*Standby Led is not set (invalid input) |
| SETSOURCE | Set source as enable/disable. | string n, integer b (n = HDMI1, n = HDMI2, n = HDMI3, n = HDMI4, n = DP, n = OPS, n = TYPE-C, n = WIDI) (b = 1(enable), b = 0(disable)) | #*Selected source n #*Enable/Disable state :b |
| GETSOURCE | Gets source. | Gets source. | #*source is ... |
| SETSOURCENAME | Changes source name with given index. | string n - integer m n = New source name m = Source index (HDMI1 = 5, HDMI2 = 8, HDMI3 = 9, HDMI4 = 10, DP = 6, OPS = 7, TYPE-C = 11, WIDI = 15) (Example=SETSOURCENAME ASLI 5) | #* <old source name> source name changed with <new source name> or #*Source not available |
| GETSOURCENAME | Gets the source name with given index. | integer n n = Source index (HDMI1 = 5, HDMI2 = 8, HDMI3 = 9, HDMI4 = 10, DP = 6, OPS = 7, TYPE-C = 11, WIDI = 15) | #*Source name is ... or #*Source not available |
| KEY | Send key. | string-integer n (n = 0, n = 1,, n = up,, n = menu,ext.) | n key sent |
| GETSWVERSION | Returns the software version of panel. | no parameter | #*V... |
| GETMODELNO | Get model no. | no parameter | *Model no: ... |

| | | | |
|--------------------|---|---|---|
| SETMODELNO | Set model no. | string-integer n | ##*ACK or ##*NACK |
| GETSERIALNO | Get serial no. (returns ##*NACK if no serial number has been set) | no parameter | ##*<Serial no> or ##*NACK |
| SETSERIALNO | Set serial no. | string-integer n | ##*ACK or ##*NACK |
| SETFTIPIN | Set FTI PIN number | integer n (n is a four digit number) | ##*FTI PIN was set to n |
| GETFTIPIN | Get FTI PIN number | no parameter | ##*The FTI PIN is n |
| CHANGELNG | Change active language | integer n n = language(0="Turkish", 1="English", 2="Albanian", 3="Arabic", 4="Azerbaijani", 5="Belarusian", 6="Bosnian", 7="Bulgarian", 8="Czech", 9="Danish", 10="Dutch", 11="Estonian", 12="Finnish", 13="French", 14="German", 15="Gaelic", 16="Greek", 17="Hebrew", 18="Croatian", 19="Hungarian", 20="Italian", 21="Kazakh", 22="Latvian", 23="Lithuanian", 24="Macedonian", 25="Norwegian", 26="Persian", 27="Polish", 28="Portuguese", 29="Romanian", 30="Russian", 31="Slovak", 32="Slovenian", 33="Spanish", 34="Serbian", 35="Swedish", 36="Thai", 37="Ukranian", 38="Vietnamese", 39="Japanese") Example: CHANGELNG 0 (To set system language to Turkish) | ##* [old language] language changed to n or ##*Incorrect item parameter entered |

| | | | |
|------------------------|--|--|---|
| SETCOUNTRY | Set country | string n Valid country strings are below: TURKEY, UK, ALBANIAN, AUSTRALIA, AUSTRIA, BELARUSIAN, BELGIUM, BULGARIA, COLOMBIA, CROATIA, CYPRUS, CZECH, DENMARK, ESTONIA, FINLAND, FRANCE, GERMANY, GREECE, HUNGARY, INDIA, IRAQ, IRELAND, ISRAEL, ITALY, JORDAN, LATVIA, LEBANON, LITHUANIA, LUXEMBOURG, MACEDONIA, MALTA, NETHERLANDS, NEW ZEALAND, NORWAY, IRAN, POLAND, PORTUGAL, ROMANIA, RUSSIA, SAUDI ARABIA, SERBIA, SLOVAKIA, SLOVENIA, SPAIN, SWEDEN, SWITZERLAND, THAILAND, UKRAINE, VIETNAM, JAPAN | #* setCountry() set to n or #*Incorrect item parameter entered |
| GETCOUNTRY | Get country | no parameter | #*COUNTRY IS : |
| SETCUSTOMERNAME | Change Customer name | string n (n = Customer name) | #*Customer name is set as n |
| GETCUSTOMER | Get Customer name | no parameter | #*Customer: [CUSTOMER]#* |
| BUILDINFO | Reports the build info. | no parameter | #*Build info = ... #*Build Date = ... |
| FACTORY | Load factory settings to NVRAM. Settings are updated with defaults. | no parameter | #*Factory Settings were loaded to NVRAM. |
| RESET | Reset the device. | no parameter | #*Reset hardware |
| MENUTIMEOUT | Set menu time out mode. | integer n (n = 0 , n = 15, n = 30, n = 45, n = 60) | #*set menu timeout mode to OFF or #*set menu timeout mode to 60 or #*Invalid menu timeout mode |

| | | | |
|----------------------------|---|--|--|
| GETMENUTIMEOUT | Get menu time out mode | no parameter | <p>##*menu timeout mode is OFF</p> <p>or</p> <p>##*menu timeout mode is n</p> <p>or</p> <p>##*can not get menu timeout mode</p> <p>Note: Above n is one of (15, 30,45, 60)</p> |
| AUTOTVOFF | Set auto panel off level. | integer n (0 = off, 1 = 1 HOUR, 2 = 2 HOUR, 3 = 3 HOUR, 4 = 4 HOUR, 5 = 5 HOUR, 6 = 6 HOUR, 7 = 7 HOUR, 8 = 8 HOUR) | <p>##*set auto display off mode to n</p> <p>or</p> <p>##*set auto display off mode to OFF</p> <p>or</p> <p>##*auto display off must be Integer and between [0-8]</p> |
| GETAUTOTVOFF | Get auto panel off mode. | no parameter | <p>##*auto Display off is n</p> <p>or</p> <p>##*auto Display off is OFF</p> |
| GETSTANDBY | Get standby on/off. | no parameter | <p>##*standby off</p> <p>or</p> <p>##*standby on</p> |
| INTERACTIVE STANDBY | Enter active standby state | no parameter | <p>##*Display will be sent to Active Standby state!</p> <p>or</p> <p>##*Display is in Active Standby state already!</p> |
| EXITACTIVESTANDBY | Exit active standby state | no parameter | <p>##*Display will be turned on!</p> <p>or</p> <p>##* Display is not in Active Standby state!</p> |
| GETTVLIFETIME | Prints panel life time in minutes. | no parameter | ##*Display Life Time: n |
| SETPOWERONDELAY | Set poweron delay level | integer n (0<=n<=20, delay is calculated as 100ms*n) | <p>##*Power on delay set to ... ms</p> <p>or</p> <p>##*NACK</p> |
| GETPOWERONDELAY | Get poweron delay level | no parameter | ##*The power on delay is ... ms |
| SIGNAGERESET | Set all items in the signage settings menu to their default values. | no parameter | ##*All signage settings set to default values |
| SWOL | Set Wake on Lan option | integer n (n = 1 (enable), n = 0 (disable)) | <p>##*Wake on Lan is set to enable.</p> <p>or</p> <p>##*Wake on Lan is set to disable.</p> <p>or</p> <p>##*NACK</p> |

| | | | |
|-------------------------------|--|---|---|
| GWOL | Get Wake on Lan option | no parameter | ##Wake on Lan is enable. or ##Wake on Lan is disable. |
| TIME | Display the current date and time. | no parameter | Time = ... |
| SETTIMEMODE | Set time mode | string n ("auto", "manual") | ##set time mode to n or ##invalid input type |
| GETTIMEMODE | Get time mode | no parameter | ##time mode is n Note: Above n is "auto" or "manual". |
| SETPOWERMODE | Set Power Mode (SETPOWERMODE n) | string n (Eco,Reactive) | ##Set power mode to ... or ##Invalid power mode parameter (<Eco/Reactive>) |
| GETPOWERMODE | Returns Power Mode (Eco or Reactive) | no parameter | ##Power mode is |
| GETCPU TEMPERATURE | Gets cpu temperature | no parameter | ##cpu temperature is ... |
| GETRAMUSAGE PERCENTAGE | Gets ram usage percentage | no parameter | ##memory usage percentage is ... or ##can not get memory usage percentage |
| set_video_output | Switch on and off, all the Panel Supply Voltages and Video Signals | integer n (0 = off, 1 = on) | ##Video output is set to 0 or ##Video output is set to 1 or ##Invalid parameter |
| screen_capture_usb | Capture specified surface as png to USB stick. | integer n (0 for UI, 8 for video layer) | ##Screen capture is successfull. or ##Screen capture failed! |
| VIDOFF | Hides video. | no parameter | ##Video off. |
| VIDON | Shows video. | no parameter | ##Video on. |
| GETVIDSTATE | Get video state. | no parameter | ##Video is on or ##Video is off |
| SETSCHEDULER | enables/disables scheduler | string n (N_X, N_X) (N is scheduler number (1,2,3,4), X is "ON" or "OFF") ----- "SETSCHEDULER N_X" (SETSCHEDULER 1_OFF) (SETSCHEDULER 2_ON) | ##The scheduler Plan N (1,2,3,4) is set to X (ON, OFF) or ##Wrong parameter entered |

| | | | |
|-----------------------------|---|---|---|
| <p>GETSCHEDULER</p> | <p>gets scheduler enabled/ disabled</p> | <p>"GETSCHEDULER N" (N is scheduler number) ----- "GETSCHEDULER 1"</p> | <p>#*The scheduler Plan N (1,2,3,4) is ... (ON, OFF) or #*Wrong parameter entered</p> |
| <p>SETSCHEDULEOP</p> | <p>sets scheduler parameters</p> | <p>string n (schedulerplannumber_ onenabled_ontime_ offenabled_ offtime_days_ sourceorbrightness_value in format: A_B_hh:mm_C_ hh:mm_D_E_F) A = 1, 2, 3, 4 B = 0, 1 C = 0, 1 D = XXXXXXX (X = 0, 1) E = 0, 1 (0 = source, 1 = brightness) F; if E = 0, Available source names: Last Source USB DP OPS Type C HDMI 1 HDMI 2 HDMI 3 HDMI 4 if E = 1, backlight value = 0, 5, 10, 15, 20, 25, 30, 35, 40, 45, 50, 55, 60, 65, 70, 75, 80, 85, 90, 95, 100 ----- "SETSCHEDULEOP number_ enabled_ontime_ offenabled_ offtime_days_source" (SETSCHEDULEOP 4_1_ 08:00_1_22:00_0111110_0 _HDMI 1)</p> | <p>#*Schedule parameters are ... (set/not set).</p> |

| | | | |
|----------------------|-------------------------------|--|---|
| GETSCHEDULEOP | gets scheduler parameters | <p>"GETSCHEDULEOP N" (N is scheduler number) N=1, 2, 3, 4 ----- ----- GETSCHEDULEOP 1"</p> | <p>##Scheduler Plan N (1,2,3,4) on/off time, source and days are: (hh:mm_hh:mm_source_ days) or ##Scheduler Plan N (1,2,3,4) on/off time, backlight and days are: (hh:mm_hh:mm_ backlight_days) or ##Scheduler Plan N (1,2,3,4) is not set or ##Wrong parameter entered</p> |
| STARTFTI | start first time installation | no parameter | |

| MODE COMMANDS | | | |
|-------------------------|---|---|--|
| Command | Description | Parameter | Return |
| SETSTARTUPSOURCE | Sets startup source which has been entered after power off on | integer n ($1 \leq n \leq 7$) Source Index (n=1) DP (n=2) SLOT/OPS (n=3) TYPE C (n=4) HDMI1 (n=5) HDMI2 (n=6) HDMI3 (n=7) HDMI4 | ## The startup source is set to ... or ## Invalid startup source is entered. |
| GETSTARTUPSOURCE | Gets startup source which has been entered after power off on | no parameter | ##The startup source is ... |
| SETSTARTUPMODE | Set start up mode | integer n ($0 \leq n \leq 2$) (n = 0 => On, n = 1 => Standby, n = 2 => Last) | ##The startup mode is ... or ##Invalid startup mode entered. |
| GETSTARTUPMODE | Get startup mode | no parameter | ##The startup mode is ... |
| SETPANELLOCK | Set Panel lock availability (ON,OFF) | string n (ON, OFF) | ##Set panel lock to ... or ##Invalid panel lock parameter |
| GETPANELLOCK | Get panel lock availability | no parameter | ##The panel lock is ... or ##Panel lock has not been set yet. |
| SETMAXVOLUME | Set volume maximum level | integer n ($0 \leq n \leq 100$) | ## Maximum volume limit is set to ... or ## Invalid volume parameter! |

| | | | |
|-----------------------|--------------------------|-----------------------------------|--|
| GETMAXVOLUME | Get volume maximum level | no parameter | #*Maximum volume limit is ... |
| GETMINVOLUME | Get volume minimum level | no parameter | #The minimum volume is ... |
| SETSTARTVOLUME | Set startup volume | integer n ($0 \leq n \leq 100$) | #*Start up volume is set to ... or #*Volume can not be higher than maximum volume #*Invalid volume parameter! |
| GETSTARTVOLUME | Get startup volume | no parameter | #*Start up volume is ... |

MEDIA BROWSER COMMANDS

| Command | Description | Parameter | Return |
|------------------------------|-------------------------|-------------------------------------|--|
| SETSLIDESHOW INTERVAL | set slide show interval | integer n (5, 10, 15, 20, 25, 30) | #*The slideshow interval is set to ... seconds |
| GETSLIDESHOW INTERVAL | get slide show interval | no parameter | #*The slideshow interval is ... seconds |
| SETUSBAUTOPLAY | set usb autoplay mode | string n (ON, OFF) | #*The USB autoplay is set to ... (ON, OFF) |
| GETUSBAUTOPLAY | get usb autoplay mode | no parameter | #*The USB autoplay is ... (1, 0) |
| SETMBSUBTPOS | set subtitle position | string n (Up, Down) | #*The subtitle position is set to ... (up, down) |
| GETMBSUBTPOS | get subtitle position | no parameter | #*The subtitle position is ... (up, down) |
| SETMBSUBTFONTSIZE | set subtitle font size | integer n | #*The media browser subtitle font size is set to ... |
| GETMBSUBTFONTSIZE | get subtitle font size | no parameter | #*The media browser subtitle font size is ... (font size as in setter's parameters section) |

SIGNAGE SETTINGS COMMANDS

| Command | Description | Parameter | Return |
|-------------------------------|-----------------------------------|---|---|
| GETTOTALSPACE | get total usb space | no parameter | #*The total space is ... |
| GETFREESPACE | get free usb space | no parameter | #*The free space is ... |
| OPENDISPLAY SETTINGS | Opens the Display Settings dialog | no parameter | #*Display Settings is opened |
| SETMODE_EMBEDDED TOUCH | Set the embedded touch mode | string (External,OPS,Display, TypeC,Auto) | #*Embedded touch mode is set to ***** or #*Embedded touch mode is not set (invalid input) |

| | | | |
|-----------------------|---|--|---|
| SETMODE_WIFIBT | Set the wifi&bt switch value | string wifibt string usb string (Display,OPS,Auto) | #*Wifi & BT Switch Mode is set to ***** or #*Wifi & BT Switch Mode is not set (invalid input) |
| SETMODE_USB | Set the Front&Internal USB status value | string usb string wifibt string (Display,OPS,Auto) | #*USB Mode is set to ***** or #*USB Mode is not set (invalid input) |
| SETSIGNAGEID | Set Signage ID | integer n | #*Set Signage ID Success. or #*Wrong parameter. Parameters must be integer |
| GETSIGNAGEID | Get Signage ID | no parameter | #*The signage ID is ... or #*The signage ID is 0 #*Do not forget to enter signage ID! (If return value is 0) |
| SHOWSIGNAGEID | display signage ID on screen | no parameter | #* Signage ID is ... or #* Signage ID is 0 #*Do not forget to enter signage ID! (If return value is 0) |

NETWORK COMMANDS

| Command | Description | Parameter | Return |
|------------------------|---|--------------------------|---|
| get_IP_address | Get IP address of eth0 network interface. Usage: get_IP_address | no parameter | #*IPAddr: ... |
| SAVEWIFIPROFILE | Save access point to wifi_profile. | str-int ssid, bssid key | Profile saved. or Number of profiles exceeds the maximum number to be stored. |
| Wifi | checks if given SSID wifi is found or not and returns Pass or Fail. | str-int ssid | #*Pass or #*FAIL |
| GETNETWORKTYPE | get network type (eg. GETNETWORKTYPE) | no parameter | #*the network type is <network-type> |
| SETSUBNETMASK | set subnet mask (subnet mask value should be of format nnn.nnn.nnn.nnn) (eg. SETSUBNETMASK nnn.nnn.nnn.nnn) | string "nnn.nnn.nnn.nnn" | #*set subnet mask: nnn.nnn.nnn.nnn or #*setting subnet mask is failed |
| GETSUBNETMASK | get subnet mask (eg. GETSUBNETMASK) | no parameter | #*the subnet mask is nnn.nnn.nnn |

| | | | |
|--------------------------|---|----------------------------------|---|
| SETDEFAULTGATEWAY | set default gateway (default gateway value should be of format nnn.nnn.nnn.nnn) (eg. SETDEFAULTGATEWAY nnn.nnn.nnn.nnn) | string "nnn.nnn.nnn.nnn" | ##set default gateway: nnn.nnn.nnn.nnn or ##setting default gateway is failed |
| GETDEFAULTGATEWAY | get default gateway (eg. GETDEFAULTGATEWAY) | no parameter | ##the default gateway is nnn.nnn.nnn.nnn |
| SETDNS1 | set DNS server 1 (DNS server value should be of format nnn.nnn.nnn.nnn) (eg. SETDNS1 nnn.nnn.nnn.nnn) | string "nnn.nnn.nnn.nnn" | ##set DNS server 1 to: nnn.nnn.nnn.nnn or ##setting DNS server 1 failed |
| GETDNS1 | get DNS server 1 (eg. GETDNS1) | no parameter | ##DNS server 1 is nnn.nnn.nnn.nnn |
| SETDNS2 | set DNS server 2 (DNS server value should be of format nnn.nnn.nnn.nnn) (eg. SETDNS2 nnn.nnn.nnn.nnn) | string "nnn.nnn.nnn.nnn" | ##set DNS server 2 to: nnn.nnn.nnn.nnn or ##setting DNS server 2 failed |
| GETDNS2 | get DNS server 2 (eg. GETDNS2) | no parameter | ##DNS server 2 is nnn.nnn.nnn.nnn |
| GETINTERNETSPEED | get internet speed | no parameter | ##The internet speed is ... Mbps |
| SETPROXY | Sets proxy configuration | string (nnn.nnn.nnn.nnn:nnn:nnn) | ##addr = nnn.nnn.nnn.nnn, port = nnnn |
| GETPROXY | Gets proxy configuration | no parameter | ##Current proxy is nnn.nnn.nnn.nnn:nnnn or ##No proxy address |
| CLEARPROXY | Clears proxy configuration | no parameter | ##Proxy was cleaned |

PC COMMANDS

| Command | Description | Parameter | Return |
|--------------------------|---------------------|--|---|
| SETOSDORIENTATION | Set OSD orientation | string-integer n (n = landscape, n = portrait, n = portrait2) (landscape : 0 degree rotation, portrait : 90 degree rotation, portrait2: 270 degree rotation) | ##Wrong parameter entered (landscape, portrait, portrait2) or ##The OSD orientation set OK or ##The OSD orientation set NOK |
| GETOSDORIENTATION | Get OSD orientation | no parameter | ##The OSD orientation ... |

| | | | |
|-----------------------|-------------------------|------------------------------------|---|
| SETOPSPOWER | Set OPS power status | string parameter "on" or "off" | <pre> #*Turning OPS on #*Turning OPS off #*The OPS is already on #*The OPS is already off #*The OPS is not enabled #*The OPS is not plugged in #*invalid value entered </pre> |
| GETOPSPOWER | Get OPS power status | no parameter | <pre> #*The OPS is on #*The OPS is off #*The OPS is not enabled #*The OPS is not plugged in </pre> |
| SETOPSALWAYSON | Set OPS Always on value | string parameter "true" or "false" | <pre> #*invalid value entered #*The OPS is not enabled #*OPS Always on set as true #*OPS Always on set as false </pre> |

PICTURE COMMANDS

| Command | Description | Parameter | Return |
|--------------------------|-----------------------------|--|--|
| SETBACKLIGHT | Set backlight pin status. | str-int n (n = ON, n = OFF) | <pre> #*setBacklight port to ON or #*setBacklight port to OFF </pre> |
| SETBACKLIGHTLEVEL | Set backlight level. | int n ($0 \leq n \leq 100$) | <pre> #*Backlight level set to n or #*NACK </pre> |
| GETBACKLIGHTLEVEL | Get backlight level. | no parameter | <pre> #*The backlight level is ... </pre> |
| COLOURTEMP | Set colour temperature. | str-int n (n = normal, warm, cool) | <pre> #*setColourTemp() set to n </pre> |
| GETCOLOURTEMP | Get colour temperature. | no parameter | <pre> #*Colour temp is ... </pre> |
| PICTUREMODE | Select picture mode. | Display ----> int n (1 = dynamic, 2 = natural, 3 = cinema, 4 = game, 5 = sport) Signage ----> int n (1 = signage, 2 = natural, 3 = text, 4 = game, 5 = sport) | <pre> #*setPictureMode() set to n or #*Incorrect picture mode parameter entered </pre> |
| GETPICTUREMODE | Get picture mode. | no parameter | <pre> #*Picture Mode is ... for current source </pre> |
| GETCONTRAST | Get picture contrast value. | no parameter | <pre> #*THE CONTRAST VALUE : ... </pre> |

| | | | |
|--------------------------|-------------------------------------|--|--|
| SETCONTRAST | Set picture contrast value. | int n (0 ≤ n ≤ 100) | <p>##Picture contrast value is set to n or ##Same value is set. Do nothing. or ##Incorrect parameter entered! Value must be in the range 0-100</p> |
| GETBRIGHTNESS | Get picture brightness value. | no parameter | ##THE BRIGHTNESS VALUE : ... |
| SETBRIGHTNESS | Set picture brightness value. | int n (0 ≤ n ≤ 100) | <p>##Picture brightness value is set to n or ##Same value is set. Do nothing. or ##Incorrect parameter entered! Value must be in the range 0-100</p> |
| GETSHARPNESS | Get picture sharpness value. | no parameter | ##THE SHARPNESS VALUE : ... |
| SETSHARPNESS | Set picture sharpness value. | int n (0 ≤ n ≤ 100) | <p>##Picture brightness value is set to n or ##Same value is set. Do nothing. or ##Incorrect parameter entered! Value must be in the range 0-100</p> |
| PICTUREZOOM | Set picture zoom mode. | str-int n (n = auto, 16:9, subtitle, 14:9, 14:9zoom, 4:3, full(only for HD channels), cinema) Customer Christie => (n = auto shows Overscan on Display) | <p>##setPictureZoomMode() set to n or ##Incorrect picture zoom mode parameter entered</p> |
| GETPICTUREZOOM | Get picture zoom mode. | no parameter | ##Picture zoommode is ... |
| SETNOISEREDUCTION | Set noise reduction. | str-int n (n = OFF, n = LOW, n = MEDIUM, n = HIGH) | <p>##NoiseReduction set to n or ##Missing noise reduction state</p> |
| GETNOISEREDUCTION | Get noise reduction. | no parameter | ##NoiseReduction is ... |
| BRIGHTNESSUP | Increase Brightness Level by 1 step | no parameter | <p>Picture brightness value is set to ... or Picture brightness value is at max value. You can not increase brightness level further.</p> |

| | | | |
|------------------------|-------------------------------------|--|---|
| BRIGHTNESSDOWN | Decrease Brightness Level by 1 step | no parameter | Picture brightness value is set to ... or Picture brightness value is at min value. You can not decrease brightness level further. |
| CONTRASTUP | Increase Contrast Level by 1 step | no parameter | Picture contrast value is set to ... or Picture contrast value is at max value. You can not increase contrast level further. |
| CONTRASTDOWN | Decrease Contrast Level by 1 step | no parameter | Picture contrast value is set to ... or Picture contrast value is at min value. You can not decrease contrast level further. |
| SETMICRODIMMING | Set micro dimming | str-int n (n = OFF, n = LOW, n = MEDIUM, n = HIGH) | #* Set Micro Dimming Level n or #*Invalid paramater. Set Micro Dimming Level (OFF, LOW, MEDIUM, HIGH) |
| GETMICRODIMMING | Get micro dimming | no parameter | #*Micro Dimming Level ... |
| SETCOLOURSHIFT | Set colour shift. | int n (-50 <= n <= 50) | #*Colour shift is set to n or #* Same value is set. Do nothing. #*Incorrect parameter entered ! Value must be between defined ranges |
| GETCOLOURSHIFT | Get colour shift. | no parameter | #*Colour shift is ... |
| SETWB | Set white balance value. | str-int type, value (type = redgain, greengain, bluegain, redoffset, greenoffset, blueoffset) (0 ≤ value ≤250) | #*White Balance is set to value or Invalid value for White Balance (0-255) or Invalid type for White Balance |
| INCWB | Increment white balance value by n. | str-int type n (type = redgain, greengain, bluegain, redoffset, greenoffset, blueoffset) (0 ≤ n ≤250) | #*White Balance is set to ... or Invalid value for White Balance (0-255) or Invalid type for White Balance |

| | | | |
|----------------------------|-------------------------------------|---|--|
| DECWB | Decrement white balance value by n. | str-int type n (type = redgain, greengain, bluegain, redoffset, greenoffset, blueoffset) (0 ≤ n ≤250) | ##*White Balance is set to ... or Invalid value for White Balance (0-255) or Invalid type for White Balance |
| GETWB | Get white balance value. | str-int type (type = redgain, greengain, bluegain, redoffset, greenoffset, blueoffset) | ##* type ... |
| HDR | Set HDR Mode | str-int n (n = ON, n = OFF) | HDR mode is n or Invalid parameter... |
| SETDYNAMIC CONTRAST | Set dynamic contrast. | str-int n (n = OFF, n = LOW, n = MEDIUM, n = HIGH) | ##*Dynamic contrast value is set to n or ##*Invalid paramater. Set Dynamic Contrast value (OFF, LOW, MEDIUM, HIGH) |
| GETDYNAMIC CONTRAST | Get dynamic contrast. | no parameter | ##*Dynamic contrast is ... |
| SETGAMMAPOWER | Set gamma power | int n (limits not clarified) | Gamma Power Mode is set to n |
| GETGAMMAPOWER | Get gamma power | no parameter | Gamma Power Mode is ... |
| SETGAMUTMODE | Set gamut mode | int n (limits not clarified) | Gamut Color Mode is set to n |
| GETGAMUTMODE | Get gamut mode | no parameter | Gamut Color Mode is ... |

BROWSER COMMANDS

| Command | Description | Parameter | Return |
|-----------------------|---|-----------------------------------|-----------------------|
| OPENURL | Starts the given URL and returns web page load status directly. | string-integer n <load url='n' /> | ##*status= ... url=n |
| GETURL | Gets URL of the current page if the portal is active. | no parameter | ##*URL : ... |
| SETSETTINGSURL | Sets the browser settings URL (URL set by the command is opened with long press on CMS key) | string | ##*Setting URL is set |
| GETSETTINGSURL | Gets the browser settings URL | no parameter | ##*Setting URL is ... |
| SETSTARTURL | Sets the start URL | string | ##*Start URL is set |
| GETSTARTURL | Gets the start URL | no parameter | ##*Start URL is ... |
| GETUSERAGENT | Gets portal user agent. | no parameter | ##*Current UA : ... |

| | | | |
|-------------------------|---|---|---|
| CLEARCACHE | Clear browser cache/ cookies (Private datas like web form) | no parameter | ##*Browser cookies are cleared |
| CLEARBROWSERDATA | Clear browser data files like History, Bookmarks, Speed Dial and Configuration | no parameter | ##*Browser data files are cleared |
| GETCMSSTATUS | Gets the CMS status | no parameter | ##*Do cms status assignment with SETCMSSTATUS command or Returns the value of cms status |
| SETCMSSTATUS | Sets the CMS status | string parameter max. length of 255 characters | ##*CMS status set to ... or ##*NACK |
| GETCMSPARAMS | Gets the CMS parameters | no parameter | ##*Do cms param assignment with SETCMSPARAMS command. or Returns the value of cms params |
| SETCMSPARAMS | Sets the CMS parameters | string parameter max. length of 255 characters | ##*CMS params set to ... or ##*NACK |
| SETBROWSERDEBUG | Sets the browser debug 4725 port | string n (n = ON, n = OFF) | browser debug 4725 port is enabled or browser debug 4725 port is disabled |
| SETBROWSERCORS | Set browser cors status to enable disable web security flag | int n (n = 0,1) | ##*Browser cors is enabled or ##*Browser cors is disabled or ##*Browser cors operation is failed *Reboot is required after the command is executed |
| GETBROWSERCORS | Get browser cors status | no parameter | ##*Browser cors is enabled or ##*Browser cors is disabled |

RS232 HEX Commands

Protocol Test Steps

- Before testing, please know the board type you have. There are two types of board. The UART 0 and UART 1 connections of the these boards are explained below:
 1. RJ12 is connected to UART 0, DSUB9 is connected to UART 1. Therefore, UART 0 and UART 1 could be tested separately in this type of the board
 2. RJ12 and DSUB9 both are connected to UART 0. UART 1 is supported for OPS module but not reachable. Therefore, only UART 0 could be tested in this type of the board.
- Activate HEX protocol on Display.
 - a. Enter **Display Settings > Signage Settings > Controls** menu
 - b. Change the **ASCII** option to **HEX** in **UART0** or **UART1** sub-menu item
- Open any serial port communications program (e.g Realterm). Configure serial communication settings as below:

Baud Rate : 19200 for UART0, 9600 for UART1

Parity : None

Data Bits 8

Stop Bits 1

Handshake : None

- Note that **UART0** default value: **ASCII**, **UART1** default value: **HEX**

In the tables given below, XY represents are variable byte.

All byte values are hexadecimal.

Error Responses

- **NAK reply: 15** When the display cannot understand the received command, it returns this value. In such a case, check the sending code and send the same command again.
- **Error reply: 1C 00 00** When the display cannot execute the received command for any reasons, it returns this value. In such a case, check the sending code and the setting status of the display.

| Command received by display | | | | | | | | | | | | | | | Reply sent by display for successful operation | | | Notes |
|-----------------------------|------------------|-------------|----|--------|-----------|----|----------|------|--------|----|------|----|--------------|----|--|----|----|--|
| Byte Number | | 0 | 1 | 2 | 3 | 4 | 5 | 6 | 7 | 8 | 9 | 10 | 11 | 12 | 0 | 1 | 2 | |
| | | Header | | | | | | Data | | | | | | | | | | |
| | | Header code | | Packet | Data Size | | CRC flag | | Action | | Type | | Setting code | | | | | |
| Name | Operation | L | H | | L | H | L | H | L | H | L | H | L | H | | | | |
| Monitor | ON | BE | EF | 03 | 06 | 00 | 19 | D3 | 02 | 00 | 00 | 60 | 02 | 00 | 06 | | | Power Mode (Quick Standby) should be enabled to be able to turn on the Display with this command. |
| | OFF | BE | EF | 03 | 06 | 00 | 19 | D3 | 02 | 00 | 00 | 60 | 01 | 00 | 06 | | | |
| | GET | BE | EF | 03 | 06 | 00 | 19 | D8 | 03 | 00 | 00 | 60 | 07 | 00 | 1D | 00 | XY | XY can be either 00 or 01. 00 means OFF, 01 means ON. |
| Mute | ON | BE | EF | 03 | 06 | 00 | D6 | D2 | 01 | 00 | 02 | 20 | 01 | 00 | 06 | | | |
| | OFF | BE | EF | 03 | 06 | 00 | 46 | D3 | 01 | 00 | 02 | 20 | 00 | 00 | 06 | | | |
| | GET | BE | EF | 03 | 06 | 00 | 75 | D3 | 02 | 00 | 02 | 20 | 00 | 00 | 1D | 00 | XY | XY can be either 00 or 01. 00 means OFF, 01 means ON. |
| Screen | ON | BE | EF | 03 | 06 | 00 | 6B | D9 | 01 | 00 | 20 | 30 | 01 | 00 | 06 | | | |
| | OFF | BE | EF | 03 | 06 | 00 | FB | D8 | 01 | 00 | 20 | 30 | 00 | 00 | 06 | | | |
| | GET | BE | EF | 03 | 06 | 00 | C8 | D8 | 02 | 00 | 20 | 30 | 00 | 00 | 1D | 00 | XY | XY can be either 00 or 01. 00 means OFF, 01 means ON. |
| Source | OPS | BE | EF | 03 | 06 | 00 | FE | D2 | 01 | 00 | 00 | 20 | 00 | 00 | 06 | | | |
| | HDMI | BE | EF | 03 | 06 | 00 | 0E | D2 | 01 | 00 | 00 | 20 | 03 | 00 | 06 | | | |
| | VGA | BE | EF | 03 | 06 | 00 | 6E | D2 | 01 | 00 | 00 | 20 | 01 | 00 | 06 | | | |
| | SCART2 (CVBS) | BE | EF | 03 | 06 | 00 | 00 | 00 | 01 | 00 | 00 | 20 | 04 | 00 | 06 | | | |
| | FAV | BE | EF | 03 | 06 | 00 | 00 | 00 | 01 | 00 | 00 | 20 | 05 | 00 | 06 | | | |
| Source | S-Video | BE | EF | 03 | 06 | 00 | 00 | 00 | 01 | 00 | 00 | 20 | 06 | 00 | 06 | | | |
| | HDMI2 | BE | EF | 03 | 06 | 00 | 00 | 00 | 01 | 00 | 00 | 20 | 08 | 00 | 06 | | | |
| | HDMI3 | BE | EF | 03 | 06 | 00 | 00 | 00 | 01 | 00 | 00 | 20 | 09 | 00 | 06 | | | |
| | HDMI4 | BE | EF | 03 | 06 | 00 | 00 | 00 | 01 | 00 | 00 | 20 | 0A | 00 | 06 | | | |
| | YPbPr | BE | EF | 03 | 06 | 00 | 00 | 00 | 01 | 00 | 00 | 20 | 0B | 00 | 06 | | | |
| | SCART2 (S-Video) | BE | EF | 03 | 06 | 00 | 00 | 00 | 01 | 00 | 00 | 20 | 0D | 00 | 06 | | | |
| | TV | BE | EF | 03 | 06 | 00 | 00 | 00 | 01 | 00 | 00 | 20 | 0E | 00 | 06 | | | |
| | SCART1 (CVBS) | BE | EF | 03 | 06 | 00 | 00 | 00 | 01 | 00 | 00 | 20 | 0F | 00 | 06 | | | |
| | SCART1 (S-Video) | BE | EF | 03 | 06 | 00 | 00 | 00 | 01 | 00 | 00 | 20 | 10 | 00 | 06 | | | |
| | DVD | BE | EF | 03 | 06 | 00 | 00 | 00 | 01 | 00 | 00 | 20 | 11 | 00 | 06 | | | |
| | DVI | BE | EF | 03 | 06 | 00 | 00 | 00 | 01 | 00 | 00 | 20 | 12 | 00 | 06 | | | |
| | DP | BE | EF | 03 | 06 | 00 | 00 | 00 | 01 | 00 | 00 | 20 | 13 | 00 | 06 | | | |
| | WIDI | BE | EF | 03 | 06 | 00 | 00 | 00 | 01 | 00 | 00 | 20 | 15 | 00 | 06 | | | |
| | GET | BE | EF | 03 | 06 | 00 | CD | D2 | 02 | 00 | 00 | 20 | 00 | 00 | 1D | 00 | XY | XY can be one of the following: 01: OPS, 02: HDMI, 03: VGA, 04: SCART2(CVBS), 05: FAV, 06: S-Video, 08: HDMI2, 09: HDMI3, 0A: HDMI4, 0B: YPbPr, 0D: SCART2(S-Video), 0E: TV, 0F: SCART1(CVBS), 10: SCART1(S-Video), 11: DVD, 12: DVI, 13: DP, 15: WIDI Note that all of the sources are not enabled. |

| Command received by display | | | | | | | | | | | | | | Reply sent by display for successful operation | | | Notes | |
|-----------------------------|-----------|-------------|----|--------|----|-----------|----|----------|----|--------|----|------|----|--|----|--|---|---|
| Byte Number | | 0 | 1 | 2 | 3 | 4 | 5 | 6 | 7 | 8 | 9 | 10 | 11 | 12 | 0 | 1 | | 2 |
| | | Header | | | | | | Data | | | | | | | | | | |
| | | Header code | | Packet | | Data Size | | CRC flag | | Action | | Type | | Setting code | | | | |
| Name | Operation | L | H | L | H | L | H | L | H | L | H | L | H | | | | | |
| Volume | GET | BE | EF | 03 | 06 | 00 | 31 | D3 | 02 | 00 | 01 | 20 | 00 | 00 | 1D | 00 | XY | |
| | INCREMENT | BE | EF | 03 | 06 | 00 | 57 | D3 | 04 | 00 | 01 | 20 | 00 | 00 | 06 | | | |
| | DECREMENT | BE | EF | 03 | 06 | 00 | 86 | D2 | 05 | 00 | 01 | 20 | 00 | 00 | 06 | | | |
| | SET | BE | EF | 03 | 06 | 00 | 31 | D3 | 03 | 00 | 01 | 20 | 01 | XY | 06 | | XY can take 00 as a minimum and 1D as a maximum. | |
| OPS Power | ON | BE | EF | 03 | 06 | 00 | BA | D2 | 01 | 00 | 05 | 20 | 01 | 00 | 06 | | | |
| | OFF | BE | EF | 03 | 06 | 00 | 2A | D3 | 01 | 00 | 05 | 20 | 00 | 00 | 06 | | | |
| | GET | BE | EF | 03 | 06 | 00 | 19 | D3 | 02 | 00 | 05 | 20 | 00 | 00 | 1D | 00 | XY XY can be either 00 or 01. 00 means OFF, 01 means ON. | |
| Backlight | GET | BE | EF | 03 | 06 | 00 | 89 | D2 | 02 | 00 | 03 | 20 | 00 | 00 | 1D | 00 | XY | |
| | INCREMENT | BE | EF | 03 | 06 | 00 | EF | D2 | 04 | 00 | 03 | 20 | 00 | 00 | 06 | | | |
| | DECREMENT | BE | EF | 03 | 06 | 00 | 3E | D3 | 05 | 00 | 03 | 20 | 00 | 00 | 06 | | | |
| | SET | BE | EF | 03 | 06 | 00 | 89 | D2 | 03 | 00 | 03 | 20 | 01 | XY | 06 | | range: 0x64-0x1E | |
| | RESET | BE | EF | 03 | 06 | 00 | 58 | D3 | 06 | 00 | 03 | 20 | 00 | 00 | 06 | | | |
| Auto Adjust | ON | BE | EF | 03 | 06 | 00 | 32 | D4 | 01 | 00 | 19 | 20 | 01 | 00 | 06 | | Auto Adjust command is for only VGA. | |
| | OFF | BE | EF | 03 | 06 | 00 | A2 | D5 | 01 | 00 | 19 | 20 | 00 | 00 | 06 | | | |
| Keypad Lock | ON | BE | EF | 03 | 06 | 00 | 93 | 97 | 01 | 00 | 11 | 24 | 01 | 00 | 06 | | | |
| | OFF | BE | EF | 03 | 06 | 00 | 03 | 96 | 01 | 00 | 11 | 24 | 00 | 00 | 06 | | | |
| | GET | BE | EF | 03 | 06 | 00 | 30 | 96 | 02 | 00 | 11 | 24 | 00 | 00 | 1D | 00 | XY XY can be either 00 or 01. 00 means OFF, 01 means ON. | |
| Remote Controller Lock | ON | BE | EF | 03 | 06 | 00 | 77 | 97 | 01 | 00 | 16 | 24 | 00 | 00 | 06 | | | |
| | OFF | BE | EF | 03 | 06 | 00 | E7 | 96 | 01 | 00 | 16 | 24 | 01 | 00 | 06 | | | |
| | GET | BE | EF | 03 | 06 | 00 | 44 | 97 | 02 | 00 | 16 | 24 | 00 | 00 | 1D | 00 | XY XY can be either 00 or 01. 00 means OFF, 01 means ON. | |
| OSD Menu | ON | BE | EF | 03 | 06 | 00 | 6A | 63 | 01 | 00 | 00 | 37 | 01 | 00 | 06 | | | |
| | OFF | BE | EF | 03 | 06 | 00 | FA | 62 | 01 | 00 | 00 | 37 | 00 | 00 | 06 | | | |
| Contrast | GET | BE | EF | 03 | 06 | 00 | FD | D3 | 02 | 00 | 04 | 20 | 00 | 00 | 1D | 00 | XY | |
| | SET | BE | EF | 03 | 06 | 00 | FD | D3 | 03 | 00 | 04 | 20 | 01 | XY | 06 | | range: 0x4E - 0xB2 | |
| | INCREMENT | BE | EF | 03 | 06 | 00 | 9B | D3 | 04 | 00 | 04 | 20 | 00 | 00 | 06 | | | |
| | DECREMENT | BE | EF | 03 | 06 | 00 | 4A | D2 | 05 | 00 | 04 | 20 | 00 | 00 | 06 | | | |
| Auto Position | EXECUTE | BE | EF | 03 | 06 | 00 | 91 | D0 | 06 | 00 | 0A | 20 | 00 | 00 | 06 | | | |
| Colour Temperature | INCREMENT | BE | EF | 03 | 06 | 00 | 0B | F5 | 10 | 00 | B0 | 30 | 03 | 00 | 06 | | 9300K, 6500K, 13000K | |
| | DECREMENT | BE | EF | 03 | 06 | 00 | CB | F8 | 01 | 00 | B0 | 30 | 13 | 00 | 06 | | 9300K, 6500K, 13000K | |
| | GET | BE | EF | 03 | 06 | 00 | C8 | F5 | 02 | 00 | B0 | 30 | 00 | 00 | 1D | 00 | XY XY takes one of the followings: 00=9300K, 01=6500K, 02=13000K | |
| Clock | INCREMENT | BE | EF | 03 | 06 | 00 | 19 | D4 | 03 | 00 | 02 | 21 | 03 | 00 | 06 | | Clock commands are for VGA Clock. They would work independently of the selected source. | |
| | DECREMENT | BE | EF | 03 | 06 | 00 | 19 | D5 | 03 | 00 | 02 | 21 | 04 | 00 | 06 | | | |
| | GET | BE | EF | 03 | 06 | 00 | 19 | D7 | 03 | 00 | 02 | 21 | 06 | 00 | 1D | 00 | XY XY would be in the range of 00 and 64 | |
| Phase | INCREMENT | BE | EF | 03 | 06 | 00 | 2F | 83 | 04 | 00 | 03 | 21 | 00 | 00 | 06 | | Phase commands are for VGA Phase shift. They would work independently of the selected source. | |
| | DECREMENT | BE | EF | 03 | 06 | 00 | FE | 82 | 05 | 00 | 03 | 21 | 00 | 00 | 06 | | | |
| | GET | BE | EF | 03 | 06 | 00 | 49 | 83 | 02 | 00 | 03 | 21 | 00 | 00 | 1D | 00 | XY XY would be in the range of 00 and 64 | |
| H-Position | INCREMENT | BE | EF | 03 | 06 | 00 | 97 | 82 | 04 | 00 | 01 | 21 | 00 | 00 | 06 | | | |
| | DECREMENT | BE | EF | 03 | 06 | 00 | 46 | 83 | 05 | 00 | 01 | 21 | 00 | 00 | 06 | | | |
| GET | BE | EF | 03 | 06 | 00 | F1 | 82 | 02 | 00 | 01 | 21 | 00 | 00 | 1D | 00 | XY XY would be in the range of 00 and 64. Central position is 32. | | |

| Command received by display | | | | | | | | | | | | | | Reply sent by display for successful operation | | | Notes | |
|------------------------------|-----------|-------------|----|--------|-----------|----|----------|------|--------|----|------|----|--------------|--|----|----|-------|---|
| Byte Number | | 0 | 1 | 2 | 3 | 4 | 5 | 6 | 7 | 8 | 9 | 10 | 11 | 12 | 0 | 1 | | 2 |
| | | Header | | | | | | Data | | | | | | | | | | |
| | | Header code | | Packet | Data Size | | CRC flag | | Action | | Type | | Setting code | | | | | |
| Name | Operation | L | H | | L | H | L | H | L | H | L | H | L | H | | | | |
| V-Position | INCREMENT | BE | EF | 03 | 06 | 00 | 6B | 83 | 04 | 00 | 00 | 21 | 00 | 00 | 06 | | | |
| | DECREMENT | BE | EF | 03 | 06 | 00 | BA | 82 | 05 | 00 | 00 | 21 | 00 | 00 | 06 | | | |
| | GET | BE | EF | 03 | 06 | 00 | 0D | 83 | 02 | 00 | 00 | 21 | 00 | 00 | 1D | 00 | XY | |
| Colour Temp Gain R | INCREMENT | BE | EF | 03 | 06 | 00 | 52 | F4 | 04 | 00 | B1 | 30 | 00 | 00 | 06 | | | |
| | DECREMENT | BE | EF | 03 | 06 | 00 | 83 | F5 | 05 | 00 | B1 | 30 | 00 | 00 | 06 | | | |
| | GET | BE | EF | 03 | 06 | 00 | 34 | F4 | 02 | 00 | B1 | 30 | 00 | 00 | 1D | 00 | XY | |
| Colour Temp Gain G | INCREMENT | BE | EF | 03 | 06 | 00 | 16 | F4 | 04 | 00 | B2 | 30 | 00 | 00 | 06 | | | |
| | DECREMENT | BE | EF | 03 | 06 | 00 | C7 | F5 | 05 | 00 | B2 | 30 | 00 | 00 | 06 | | | |
| | GET | BE | EF | 03 | 06 | 00 | 70 | F4 | 02 | 00 | B2 | 30 | 00 | 00 | 1D | 00 | XY | |
| Colour Temp Gain B | INCREMENT | BE | EF | 03 | 06 | 00 | EA | F5 | 04 | 00 | B3 | 30 | 00 | 00 | 06 | | | |
| | DECREMENT | BE | EF | 03 | 06 | 00 | 3B | F4 | 05 | 00 | B3 | 30 | 00 | 00 | 06 | | | |
| | GET | BE | EF | 03 | 06 | 00 | 8C | F5 | 02 | 00 | B3 | 30 | 00 | 00 | 1D | 00 | XY | |
| Freeze | EXECUTE | BE | EF | 03 | 06 | 00 | 00 | 00 | 06 | 00 | C0 | 30 | 00 | 00 | 06 | | | |
| Toggles video freeze status. | | | | | | | | | | | | | | | | | | |

Maximum Pixel Rates

Please note that connection ports and other features shown here may vary depending on the Display model.
For Ultra HD panels,

| Source | Max. Resolution | Colour Space | Bits/Component | Pixel/Rate |
|----------------|-----------------|----------------|----------------|------------|
| HDMI | 4K@60Hz | YCbCr4:4:4/RGB | 8 bit | 594MHz |
| OPS (Optional) | 4K@60Hz | YCbCr4:4:4/RGB | 8 Bit | 594MHz |

Input Matrix

Please note that connection ports and other features shown here may vary depending on the Display model.

| Timing | | fH (kHz) | fV (Hz) | Dot clock (MHz) | Input | | |
|------------|--------------------------|------------|---------|-----------------|-------|--------|----|
| | | | | | HDMI | Type-C | DP |
| VESA | 720 x 400 | 31.5 | 70.156 | 26.25 | ○ | ○ | ○ |
| | 640 x 480 | 31.469 | 59.95 | 25.175 | ○ | ○ | ○ |
| | 800 x 600 | 37.879 | 60.317 | 40 | ○ | ○ | ○ |
| | 1024 x 768 | 48.363 | 60.004 | 65 | ○ | ○ | ○ |
| | 1360 x 768 | 47.712 | 60.015 | 85.5 | ○ | ○ | ○ |
| HD | 1280x720p | 37.5 | 50 | 74.25 | ○ | ○ | ○ |
| | | 44.995 | 59.94 | 74.176 | ○ | ○ | ○ |
| | | 45 | 60 | 74.25 | ○ | ○ | ○ |
| | 1920x1080i | 28.13 | 50 | 74.25 | ○ | ○ | ○ |
| | | 33.716 | 59.94 | 74.175 | ○ | ○ | ○ |
| | | 33.75 | 60 | 74.25 | ○ | ○ | ○ |
| | 1920x1080p | 56.25 | 50 | 148.5 | ○ | ○ | ○ |
| | | 67.432 | 59.95 | 148.35 | ○ | ○ | ○ |
| | | 67.5 | 60 | 148.5 | ○ | ○ | ○ |
| | UHD (Only for 4K models) | 3840x2160p | 67.5 | 30 | 297 | ○ | ○ |
| 3840x2160p | | 135 | 60 | 594 | ○ | ○ | ○ |

Supported Media Formats from USB

Video Decoder

| Codec | Verified Max. Performance | Audio Codec | Container |
|------------|---------------------------|----------------------------|-----------------------------|
| MPEG-1 | 1920x1080P @ 60fps | AC3 | DAT, MPEG, MPG, TS |
| MPEG-2 | 1920x1080P @ 60fps | MP3, PCM | MPEG, MPG, M2V, TS, TP, VOB |
| MPEG-4 ASP | 1920x1080P @ 60fps | MP3, AC-3, AAC, PCM, ADPCM | AVI, MP4, MOV, 3GP |
| MJPEG | 1920x1080p @ 30fps | MP3, U-LAW | AVI |

| Codec | Verified Max. Performance | Audio Codec | Container |
|---------------|---|--|---|
| XviD | 1920x1080p @ 30fps | AC3, MP3 | AVI, OGM |
| H.263 | 720x576p @ 30fps | MP3, AC-3, AAC, AMR-NB | 3GP, 3G2, MOV, MP4 |
| H.264 | 3840x2160 @ 30fps 100Mbps | AAC, AAC-LC, MP3, AC3, PCM, Vorbis, AMR-NB | AVI, MOV, MP4, MKV, TS, M2TS, MTS, M4V, FLV, F4V, PMP |
| H.265 Main 10 | 7680x4320 @ 24fps 80Mbps, 3840x2160 @ 60fps 80Mbps | AAC, AC3 | TS, MP4, MKV |
| VC-1 | 1920x1080p @ 25fps | AC3, PCM, DTS | M2TS, MPEG |
| WMV3 | 1280x720p @ 30fps | AC3 | ASF, MKV |
| AVS-P16 | 1920x1080p @ 30fps | - | - |
| AVS-P2 Jizhun | 720x576p @ 30fps | - | TS |
| AVS2 | 3840x2160p @ 60fps | - | TS |
| VP9 Profile-2 | 7680x4320 @ 24fps VP9 67Mbps, 4096x2304p @ 60fps VP9 Profile-2 60Mbps | Vorbis | .webm/.vp9/.ivf |
| VP8 | 1920x1080p @ 30fps | Vorbis | .webm/.mkv |
| AV1 | 3840x2160p @ 60fps 14.6Mbps | AAC, PCM, AC3 | MP4, TS |

Video Encoder

| Codec | Verified Max. Performance | Audio Codec | Container |
|-------|---------------------------|-------------|-----------|
| H.264 | 1920x1080p @ 30fps | AAC | - |

Image Decoder

| Codec | Resolution | Container |
|------------------------|----------------|-----------|
| JPEG baseline/Progress | No restriction | JPG, JPEG |
| BMP | No restriction | BMP |
| GIF | No restriction | JPG, JPEG |

| Codec | Resolution | Container |
|-------|----------------|-----------|
| PNG | No restriction | PNG |

Image Encoder

Software image encoder supported.

Audio Decoder

| Codec | Channel | Bit Rate | Sample rate | Container |
|---------------------------------|---------|---------------------------|-------------|---------------|
| MPEG 1/2/2.5, Audio Layer 3 | 2 | 8 – 320 kbps, CBR and VBR | 8 – 48 kHz | MP2/MP3 |
| PCM, IMA-ADPCM, MS-ADPCM, U-Law | 5,1 | Up to 1.5Mbps | 8 – 48 kHz | WAV |
| Vorbis | 5,1 | - | 8 – 96 kHz | OGG |
| Flac | 5,1 | VBR | 8 – 96 kHz | FLAC |
| APE | 2 | VBR | 8 – 48 kHz | Ape |
| AAC-LC, AAC-HE(AAC+) | 5,1 | VBR | 8 – 96 kHz | AAC/M4A |
| PCMA-LAW | 5,1 | - | 8 – 48 kHz | AIF/AIFF/ALAW |
| ALAC | 2 | VBR | 8 – 48 kHz | alac |
| WMA Version 7, 8, 9 | 5,1 | 8 – 320 kbps, CBR and VBR | 8 – 96 kHz | WMA |

Audio Encoder

Software audio encoder supported.

Movie Subtitle

| Format | Container |
|---------------------------|-----------|
| SAMI | SMI |
| Advanced Substation Alpha | ASS / SSA |
| SubRip | SRT |
| DVD | SUB |
| Blue Ray | PGS |
| Timed text | SBTL |
| Aqtitle | AQT |
| Lyric | LRC |
| MircoDVD | SUB |
| Mplayer1/2 | MPL |
| Mpsub | SUB |

| Format | Container |
|------------------------------|-----------|
| Phoenix Japanimation Society | PJS |
| subviewer1.0/2.0 | SUB |
| Text | TXT |
| Vplayer | TXT |

| Format | Container |
|----------------------------|------------------|
| Extensible Markup Language | XML |
| DVB-SUB | DVB |
| Jacosub | JS |

System Features

Panel

| | | |
|-----------------|--------------------------|-----|
| Panel type | 86" 16/7 DLED | |
| Resolution | 3840x2160 (16:9) -UHD | |
| Visual angle | Horizontal | 89° |
| | Perpendicular | 89° |
| Max. brightness | Typ: 400 cd/m2 | |
| H-Frequency | 60 Khz | |
| V-Frequency | 67,5 Khz | |

Audio

2 x 10 W Audio Output Power

Network Connection

1 x Ethernet (LAN) for Internet connectivity

802.11 a/b/g/n/ac built in WLAN support

Input/Output Ports

1 x RS232 port (3,5 mm)

1 x Ethernet port

1 x USB 3.0 port

1 x USB 2.0 port

1 x Micro USB port (for touch only)

1 x Internal USB 2.0 port

1 x Micro SD port

4 x HDMI 2.0 In port (1.4 for FHD panels)

1 x IR port

1 x Headphone/Line Out port

1 x HDMI Out port

1 x SPDIF Optical Out port

1 x RJ12 port (for service use only)

OPS

Up to 40W

Power

AC 110-240V~50-60Hz, 400W

Weight (kg)

62

Display Dimensions DxLxH (mm)

1962.3mm x 1133mm x 92.5mm

Wireless LAN Transmitter Specifications

| Frequency Ranges | Max Output Power |
|---------------------------------|------------------|
| 2400 - 2483,5 MHz (CH1 - CH13) | < 100 mW |
| 5150 - 5250 MHz (CH36 - CH48) | < 200 mW (*) |
| 5250 - 5350 MHz (CH52 - CH64) | < 200 mW (*) |
| 5470 - 5725 MHz (CH100 - CH140) | < 200 mW (*) |

(*) < 100 mW for the Ukraine

Country Restrictions

The Wireless LAN equipment is intended for home and office use in all EU countries, the UK and Northern Ireland (and other countries following the relevant EU and/or UK directive) without any limitation except for the countries mentioned below.

| Country | Restriction |
|--------------------|---|
| Bulgaria | General authorisation required for outdoor use and public service |
| Italy | If used outside of own premises, general authorisation is required |
| Greece | Indoor use only for 5470 MHz to 5725 MHz band |
| Luxembourg | General authorisation required for network and service supply (not for spectrum) |
| Norway | Radio transmission is prohibited for the geographical area within a radius of 20 km from the centre of Ny-Ålesund |
| Russian Federation | Indoor use only |
| Israel | 5 GHz band only for 5180 MHz-5320 MHz range |

The requirements for any country may change at any time. It's recommended that user checks with local authorities for the current status of their national regulations for 5 GHz wireless LAN's.

Warning

Surges could cause data loss except monitoring modes.

Accessories Included

- Remote Control
- Batteries: 2 x AAA
- Instruction Book
- Quick Start Guide

Information for Users on Disposal of Old Equipment and Batteries

[European Union only]

Equipment bearing these symbols should not be disposed as general household waste.

You should look for appropriate recycling facilities and systems for the disposal of these products.

Note: The sign Pb below the symbol for batteries indicates that this battery contains lead.

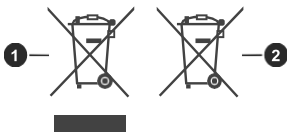

- ① Products
- ② Battery

Licence Notification

The terms HDMI, HDMI High-Definition Multimedia Interface, HDMI trade dress and the HDMI Logos are trademarks or registered trademarks of HDMI Licensing Administrator, Inc.



Manufactured under licence from Dolby Laboratories. Dolby, Dolby Audio, and the double-D symbol are trademarks of Dolby Laboratories Licensing Corporation.



The *Bluetooth*[®] word mark and logos are registered trademarks owned by the Bluetooth SIG, Inc. and any use of such marks by Vestel Elektronik Sanayi ve Ticaret A.S. is under license. Other trademarks and trade names are those of their respective owners.

This product is protected by certain intellectual property rights of Microsoft Corporation. Use or distribution of such technology outside of this product is prohibited without a licence from Microsoft or an authorised Microsoft subsidiary.

Vesa Wall Mount Measurements

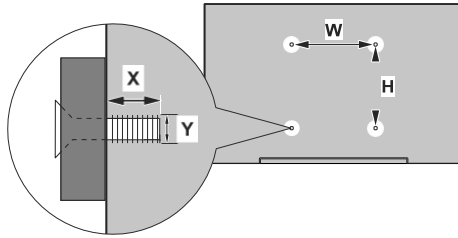

| | | |
|--------------------------------|------------|------------|
| Hole Pattern Sizes (mm) | W | H |
| | 800 | 600 |
| Screw Sizes | | |
| Length (X) | min. (mm) | 6 |
| | max. (mm) | 9 |
| Thread (Y) | M8 | |

Installation On An Indented Wall

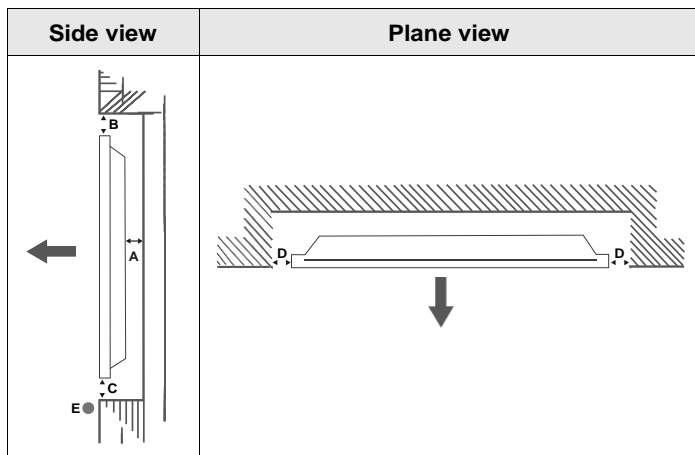

- A** Minimum 50 mm
- B** Minimum 70 mm
- C** Minimum 50 mm
- D** Minimum 50 mm
- E** Ambient temperature range: 0-35°C



When installing the product on an indented wall, allow at least the space specified above between the product and wall for ventilation and ensure that the ambient temperature is kept between 0°C-35°C.

Do not expose the product to direct sunlight.

We will take no responsibility for any damages or failures in case our products are not being used subject to these recommendations and/or instructions for use.

Safety Warnings

Laitte on liitettävä suojakoskettimilla varustettuun pistorasiaan.

Apparatet må tilkoples jordet stikkontakt.

Apparaten skall anslutas till jordat uttag.

Equipment connected to the protective earthing of the building installation through the mains connection or through other equipment with a connection to protective earthing – and to a cable distribution system using coaxial cable, may in some circumstances create a fire hazard. Connection to a cable distribution system has therefore to be provided through a device providing electrical isolation below a certain frequency range (galvanic isolator, see EN 60728-11).

Utstyr som er koplet til beskyttelsesjord via nettplugg og/eller via annet jordtilkoplett utstyr – og er tilkoplett et kabel-TV nett, kan forårsake brannfare. For å unngå dette skal det ved tilkopling av utstyret til kabel-TV nettet installeres en galvanisk isolator mellom utstyret og kabel-TV nettet.

Utrustning som är kopplad till skyddsjord via jordat vägguttag och/eller via annan utrustning och samtidigt är kopplad till kabel-TV nät kan i vissa fall medföra risk för brand. För att undvika detta skall vid anslutning av utrustningen till kabel-TV nät galvanisk isolator finnas mellan utrustningen och kabel-TV nätet.

Apparatets stikprop skal tilsluttes en stikkontakt med jord, som giver forbindelse til stikproppens jord.

CLEVERTOUCH®
by Boxlight®